



CONTROL SYSTEMS



MANTRA^{MINI}

Mantra Mini Lighting Playback Unit and Mantra Editor Programming Software User Manual

LSC Control Systems ©
+61 3 9702 8000
info@lsccontrol.com.au
www.lsccontrol.com.au



Version 4.01
November 2024

Disclaimer

LSC Control Systems Pty Ltd has a corporate policy of continuous improvement, covering areas such as product design and documentation. To achieve this goal, we undertake to release software updates for all products on a regular basis. In light of this policy, some detail contained in this manual may not match the exact operation of your product. Information contained in this manual is subject to change without notice.

In any event, LSC Control Systems Pty Ltd cannot be held liable for any direct, indirect, special, incidental, or consequential damages or loss whatsoever (including, without limitation, damages for loss of profits, business interruption, or other pecuniary loss) arising out of the use or the inability to use this product for its intended purpose as expressed by the manufacturer and in conjunction with this manual.

Servicing of this product is recommended to be carried out by LSC Control Systems Pty Ltd or its authorised service agents. No liability will be accepted whatsoever for any loss or damage caused by service, maintenance or repair by unauthorised personnel. In addition, servicing by unauthorised personnel may void your warranty.

LSC Control Systems' products must only be used for the purpose for which they were intended.

Whilst every care is taken in the preparation of this manual, LSC Control Systems takes no responsibility for any errors or omissions.

Copyright Notices

"LSC Control Systems" is a registered trademark.

Iscontrol.com.au is owned and operated by LSC Control Systems Pty Ltd.

All Trademarks referred to in this manual are the registered names of their respective owners.

The operating software of the Mantra Mini, Mantra Editor and the contents of this manual are copyright of LSC Control Systems Pty Ltd © 2021.
All rights reserved.

Contact Details

LSC Control Systems Pty Ltd

ABN 21 090 801 675

65-67 Discovery Road
Dandenong South, Victoria 3175 Australia
Tel: +61 3 9702 8000

email: info@iscontrol.com.au

web: www.iscontrol.com.au

Contents

1	Introduction	10
1.1	Conventions Used in this Manual	10
1.2	Mantra Mini Overview	10
1.3	Mantra Editor Overview	11
2	Mantra Mini Installation	12
2.1	DIN Mount	12
2.2	Power Input	12
2.3	Wi-Fi	13
2.4	Ethernet Connector	13
2.5	W Comms Connector	13
2.6	Expansion Connector	14
2.7	Isolated Input Connectors	14
2.8	Isolated DMX 1 and DMX 2 Output Connectors	14
2.9	USB Connector	15
2.10	User Button	15
2.11	Reset Button	15
3	Connection and Control Options	16
3.1	Overview	16
3.2	Installation Examples	16
4	Front Panel LED's	20
4.1	Power LED	20
4.2	Ethernet LED	20
4.3	Activity LED	20
4.4	Status LED	20
4.5	USB Show Load Indication	20
4.6	USB Software Update Indication	20
4.7	RDM Identify	20
5	QuickStart Guide	21
5.1	Overview	21
5.2	Install the Mantra Editor Software	21
5.3	Programming Mantra Mini with the Editor	21
5.3.1	Output Priority	22
5.4	Connecting the Editor to the Mantra Mini via Wi-Fi	23
5.5	Connecting the Editor to the Mantra Mini via Ethernet	25
5.6	Disconnecting the Editor from the Mantra Mini	26
5.7	Basic Programming Steps	26
5.7.1	Step 1. Patch the Fixtures	26

5.7.2	Step 2. Control the Fixtures	26
5.7.3	Step 3. Record the Output as a Cue	27
5.7.4	Step 4. Playback and Check	27
5.7.5	Step 5. Edit	27
5.7.6	Step 6. Program the Playback	27
5.7.7	Step 7. Save the Show	28
5.7.8	Step 8. Disconnect the Editor	28
6	Mantra Editor Quick Tour	29
6.1	Overview	29
6.2	Home Screen	29
6.2.1	Selecting Fixtures.	30
6.2.2	Controlling Intensity	30
6.2.3	Fixed Buttons	31
6.3	Apps	31
6.4	Clearing Fixtures	32
6.5	Playback Displayers	33
6.6	Undo	34
6.7	Keyboard Shortcuts	35
7	Patching Fixtures	36
7.1	Overview	36
7.2	Patching a fixture	37
7.2.1	Brief Description	37
7.2.2	Detailed Description	37
7.3	Patching Multiple Fixtures in One Operation	38
7.4	Multi-Patch. Patching Multiple Fixtures to the Fixture Number	39
7.5	Patching Compound Fixtures	40
7.6	View Patch	40
7.7	Un-Patching a Fixture(s)	41
7.8	Un-patch a Multi-Patched Fixture	41
7.9	Save Patch	42
7.10	Home Values	42
7.11	Fixture Editor	42
8	Rig View	43
8.1	Overview	43
8.2	Arranging Icons	43
9	Controlling Fixtures	44
9.1	Selecting Fixtures	44
9.1.1	Automatic Fixture De-select	45
9.2	Fixture Intensity	45

9.3	Fixture Attribute Apps	45
9.4	Controlling Colour	46
9.4.1	Picker App	46
9.4.2	Fine	47
9.4.3	Fan	47
9.4.1	Gels App	48
9.4.2	Sliders App	48
9.5	Controlling Position	49
9.5.1	Flip Pan/Flip Tilt	49
9.5.2	Centre	49
9.5.3	Fine Control	49
9.5.4	Ortho Control	49
9.5.5	Fan	49
9.6	Controlling Beam and Other Attributes	50
9.7	Clearing Fixtures	51
9.7.1	Clear All	51
9.7.2	Selective Clear	51
10	Animate Apps	53
10.1	Overview	53
10.2	Creating an Animation	53
10.3	Animation Controls	54
10.4	Animation Examples	55
10.4.1	Intensity Animation	55
10.4.2	Colour Animations	56
10.4.3	Pan/Tilt Animations	56
10.5	Multiple Animations	57
10.6	Recording Animations	57
10.7	Deleting Animations	57
10.8	Animations in a Chase	58
11	Shapes App	59
11.1	Overview	59
11.2	Creating a Shape	59
11.3	Recording Shapes	60
11.4	Deleting Shapes	60
11.5	Shapes in a Chase	60
12	Recording Cues	61
12.1	Overview	61
12.2	Memories / Pages	61
12.3	Record a Cue	61

12.4	Record a Cue-list (or Chase)	62
12.5	Insert a Cue in a Cue-List (or Chase)	62
12.6	Record Fixtures with No Intensity	63
12.6.1	Move in Black	63
12.6.2	Solo Cue	63
13	Playback	64
13.1	Overview	64
13.2	Mantra Mini (Stand Alone) Playback	64
13.3	Editor Playback	64
13.3.1	Playback a Cue	64
13.3.2	Playback a Cue-List	65
13.3.3	Times	65
13.3.4	All Cues Off	65
13.4	Latest Takes Precedence	66
13.5	ICPB Attributes (Filters)	66
14	Edit Memory	67
14.1	Overview	67
14.2	Fade Times	67
14.3	Link Time	68
14.4	Memory Name	68
14.5	Cue Name	68
14.6	Jump to Cue	68
14.7	Change Cue Order	69
14.8	Copy Memory	69
14.9	Copy Cue	69
14.10	Include ICPB Attributes (Filters)	69
14.11	Delete Cue	70
14.12	Delete Memory	70
14.13	Chase	70
14.14	Edit (Update) Attributes of a Cue	71
14.15	Edit Animations and Shapes	71
15	Schedule Playback	72
15.1	Overview	72
15.2	Add a Scheduled Event	72
15.2.1	Day	74
15.2.2	Date	74
15.2.3	Sunrise/Sunset	74
15.2.4	On Show Load	75
15.3	Save Event / Deactivate Event	75

16	Remote Trigger Playback	76
16.1	Overview	76
16.2	Add a Remote Trigger	76
16.3	Contact (Isolated Inputs) Remote Triggers	77
16.4	OSC Remote Triggers	79
16.5	UDP and TCP Remote Triggers	81
16.5.1	Play Memory.	83
16.5.2	Other Cues Off	84
16.5.3	Next Cue	84
16.5.4	All Cues Off	84
16.5.5	Override Disable	84
16.5.6	Evac Mode	85
16.5.7	Cue Change	86
16.6	De-activate a Remote Trigger	87
17	Show Files	89
17.1	Overview	89
17.2	New Show	90
17.3	Load Show, Save Show, Save As	90
17.3.1	Load Show	90
17.3.2	Save Show	91
17.3.3	Save Show As	91
17.4	Import Show	91
17.5	Export Show	91
17.6	Mantra Mini USB Show Load	92
18	Setup Menu	93
18.1	Overview	93
18.2	Default Fade Time	93
18.3	Delete Custom Fixtures	93
18.4	Delete Show	93
18.5	Universes	94
18.5.1	ArtNet Output	95
18.5.2	sACN Output	95
18.5.3	Override	96
18.6	View DMX	98
18.7	System Settings	98
18.7.1	Available Networks	99
18.7.1	Connecting via Ethernet.	99
18.7.2	Connecting via Wi-Fi.	99
18.8	Mantra Mini Network Settings	99

18.8.1	Mantra Mini Network Name	99
18.8.2	Mantra Mini Network Address	100
18.9	Wi-Fi Client	100
18.10	Language	101
18.11	Import Fixture Library	101
18.12	Service	101
18.13	Time Settings	101
18.13.1	Manual Time Setting	102
18.13.1	Time Zone	102
18.13.2	Daylight Savings	102
18.13.1	Location	102
18.13.1	NTP Server	103
18.14	About	103
18.14.1	Download Log File	103
18.15	Update Firmware (Software)	104
19	Fixture Editor	105
19.1	Overview	105
19.2	Creating a Custom Fixture Template	105
19.2.1	Home Positions	107
19.3	Edit a Fixture Template	107
20	Companion/StreamDeck OSC Control	108
20.1	Overview	108
20.2	Programming Companion	108
21	Touch OSC Control	110
21.1	Overview	110
21.2	Programming Touch OSC	110
22	HOUSTON X	112
23	FAQ	113
24	Feature History	113
25	Specifications	115
26	Terminology	116
26.1	Overview	116
26.2	Fixture.	116
26.3	DMX Address.	116
26.4	Template.	116
26.5	Fixture Library.	116
26.6	Attribute.	116
26.7	LTP. (Latest Takes Precedence)	116

26.8	Look	116
26.9	Cue	116
26.10	DMX512A	117
26.11	DMX Universes	117
26.12	ArtNet	117
26.13	sACN	117
26.14	RDM	117
27	Compliance Statements	118

1 Introduction

1.1 Conventions Used in this Manual

Throughout this manual, certain conventions have been used to make the meaning clearer.

- A word in **Bold** text represents a button to be clicked (or touched on a touch screen) when using the Mantra Editor programming software
- Emphasis is indicated by underlining
- *Notes or Hints are displayed in italic font*

1.2 Mantra Mini Overview

The Mantra Mini is a brilliant little playback unit with unparalleled features for control of conventional and intelligent lighting. Designed for permanent installations, it takes the popular and powerful Mantra Lite console and packages it as DIN rail mount DMX playback controller that can replay any show from a Mantra Lite console or something new recorded via the Mantra Editor programming software.



It is ideal for pre-programmed stage lighting, house and foyer lights, building exteriors, visual display lighting, trade show stands and many other uses.

It can control up to 96 lighting fixtures across 2 DMX universes that are output as DMX-512, Art-Net or sACN. Multiple Mantra Minis can be used if more than 96 fixtures are required. A built-in Wi-Fi access point or the ethernet port allows you to easily connect a computer or tablet for system configuration and cue programming using the Mantra Editor software.

Playback from the Mantra Mini can be internally controlled by a day/date time scheduler or by user input from switches or a building management system or by OSC, UDP or TCP commands over ethernet or by programable wall plates (wall plates are a future feature). Mantra Mini can also send messages to other devices by OSC, UDP or TCP commands.

Mantra Mini can also accept a DMX-512, Art-Net or sACN input from a lighting console and can automatically switch over control of its fixtures to the console when it detects the incoming signal. This allows a lighting console to take control of the Mantra Mini's lighting fixtures when required such as during a live show. When the lighting console is no longer detected, the lighting control will be automatically returned to the Mantra Mini.

System configuration, monitoring and full logging is also possible via LSC's HOUSTON X software or via RDM (Reverse Device Management).

1.3 Mantra Editor Overview



Desktop Icon

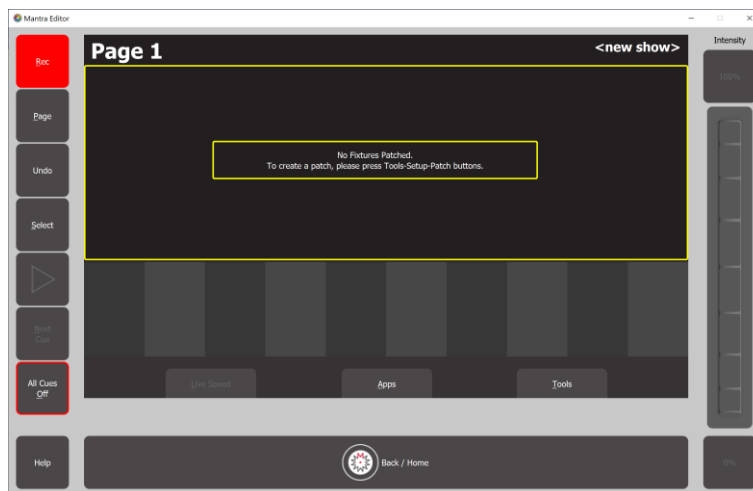

Mantra Editor

The Mantra Editor programming software emulates the powerful Mantra Lite lighting console but includes the additional features of the Mantra Mini such as the real time scheduler and remote trigger programming. It can be used to program the Mantra Mini or to off line edit Mantra Lite lighting console show files. The Mantra Editor includes all the Mantra Lite features such as the fixture library, colour pickers, cue lists and chases plus quick and easy effects such as animations and shapes.

When the Mantra Editor is connected to the Mantra Mini, it can control the Mantra Mini's fixtures allowing you to see exactly what you are programming. Once the Mantra Mini has been programmed and the show saved, the Mantra Editor is disconnected and playback can then be controlled as described above.

The free Mantra Editor software can be downloaded from "mantramini.lsccontrol.com.au". See section 5.2.

See section 6 for a quick tour of the Mantra Editor.

2 Mantra Mini Installation

2.1 DIN Mount

The Mantra Mini mounts on a standard TS35 DIN rail. The Mantra Mini is 9 DIN modules wide (157.5mm). Allow adequate ventilation and do not expose the Mantra Mini to direct sunlight or moisture. The Mantra Mini is fitted with a small internal automatic variable speed fan to internally circulate the air.

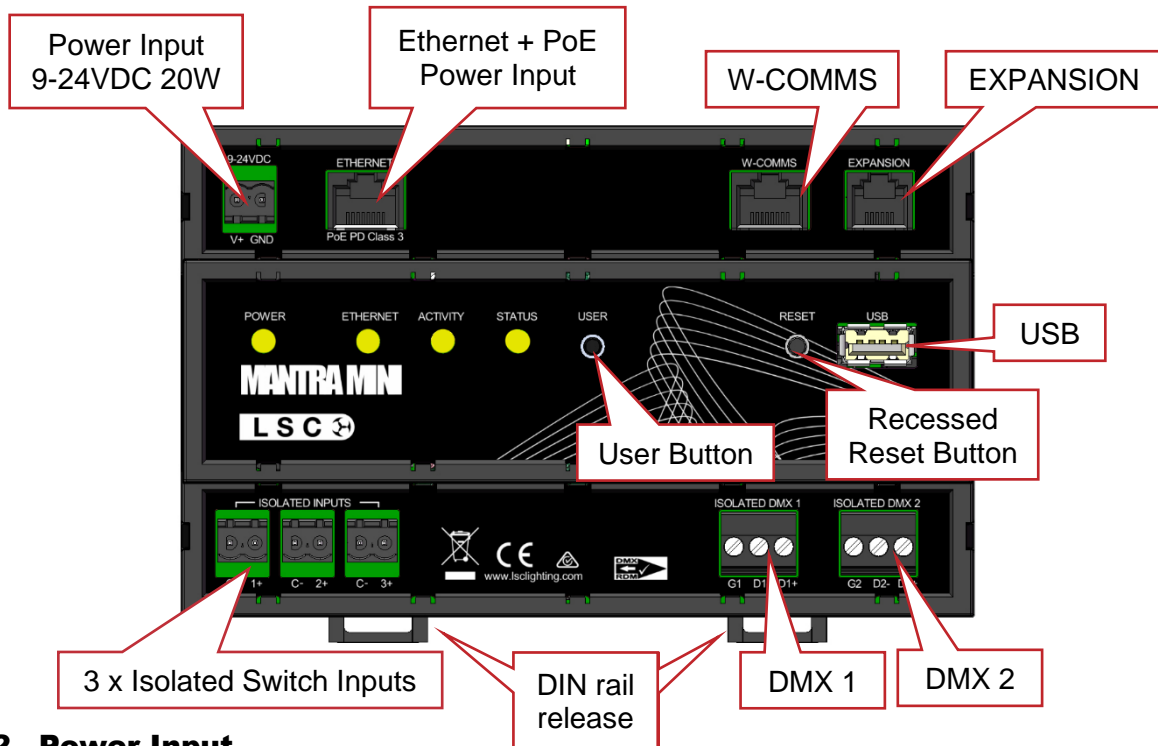

2.2 Power Input

There are two options for powering the Mantra Mini.

- 9-24 volts DC. A DIN-rail power supply (or any other suitably rated power supply) can be mounted near the Mantra Mini and connected to the 2-pole plug-in connector.



9-24V DC Power Input

- **PoE.** Connect the RJ45 “Ethernet” connector to a suitable PoE network device supplying PoE (Power over Ethernet) PD Class 3. PoE delivers power and data over a single CAT5/6 network cable.

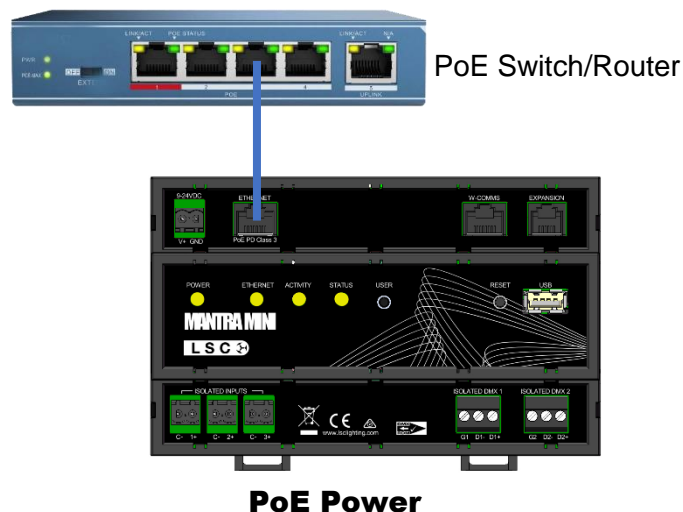

Note: If LSC Wall plate switches (future feature) are connected to the “W Comms” connector you must use the “9V-24V DC” power input.

The Mantra Mini has an in built 30 second UPS (Uninterruptible Power Supply).

2.3 Wi-Fi

Mantra Mini has short range inbuilt Wi-Fi allowing you to easily connect your computer or tablet for system configuration and cue programming using the Mantra Editor software. If the Mantra Mini is mounted inside a metal cabinet you might have to open the door to make a Wi-Fi connection. See section 5.4.

Note: The Wi-Fi connection is only required for programming and is not required for the normal operation of the Mantra Mini. Programming can also be performed using the Ethernet connector.

2.4 Ethernet Connector

The RJ45 Ethernet network connector has multiple uses:

- PoE (Power over Ethernet) (see above)
- Connecting to a Network for programming, control and monitoring. See section 5.5
- Output/Input of sACN and ArtNet. These are lighting control protocols that send DMX lighting data over a network. See section 18.5

2.5 W Comms Connector

Note: Wall plate control using the W Comms connector is a future feature.

The RJ45 “W Comms” connector will allow you to connect LSC’s 4 button wall plate switches to control the playback from the Mantra Mini. The W Comms connector provides communication and power for the wall plates. When wall plates are connected, the mantra Mini must be connected to a 9-24v power supply and not to the PoE power. LSC wall plates can also be connected via the network Ethernet connector. In this case the wall plates get their power via PoE from the network (not via the Mantra Mini).

A separate application (future release) is required to program LSC wall plates. The programming of each wall plate is stored in that wall plate. You can program the wall plates without the Mantra Mini being present.

2.6 Expansion Connector

The RJ12 “Expansion” connector is a high-speed data bus for future use.

2.7 Isolated Input Connectors

The 3 isolated (voltage free) inputs can be connected to contact closures to control:

- Evacuation lighting
- Memory playback
- De-activation of “override” mode.

See section 16.3

2.8 Isolated DMX 1 and DMX 2 Output Connectors

DMX 512-A is the industry standard for the transmission of digital control signals between lighting equipment. It is generally known as “DMX” and it utilises just a single pair of wires on which is transmitted the level information for the control of up to 512 DMX slots. Lighting fixtures, LED drivers and dimmers have a DMX input and usually a DMX output so that you can connect multiple devices in a daisy chain fashion. Do not use parallel connections. A maximum of 32 devices can be connected on a DMX output. Din mount DMX splitters are available from LSC if you need multiple feeds to run DMX to different locations.

To configure DMX, set a DMX address on each fixture and then use Mantra Mini to control each fixture based on its address. Each fixture will use a quantity of DMX channels to control its different functions as listed in its specifications. If more than 512 DMX slots are required, then more DMX outputs are required. The slot numbers on each DMX output are always 1 to 512. To differentiate between each DMX output, they are called Universe1, Universe 2, etcetera. Mantra Mini provides 2 DMX universes.

- DMX 1 outputs DMX data from U1 (Universe 1) as set in the patch.
- DMX 2 outputs DMX data from U2 (Universe 2) as set in the patch. The DMX 2 connector can also be used as a DMX Input. See section 18.5.3

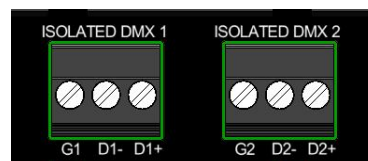

Only use specific DMX cable (available from your lighting supply company). Never use audio cable. LSC recommends using Beldon 9842 (or equivalent). The end of the DMX line must be terminated (120 ohms) to prevent the signal reflecting back up the line and causing possible errors.

Lighting fixtures and LED drivers use a range of DMX connectors. The most common connector pin-outs are:

5 pin XLR	
Pin Number	Function
1	Ground
2	- Data
3	+ Data
4	Not Used
5	Not Used

3 Pin XLR	
Pin Number	Function
1	Ground
2	- Data
3	+ Data

RJ45	
Pin Number	Function
1	+ Data
2	- Data
3	
4	
5	
6	
7	Ground
8	Ground

See section 3.2 for typical connections.

2.9 USB Connector

Insert a USB memory stick into the USB connector for software upgrades (see section 18.15) or loading show files (see section 17).

2.10 User Button

Used to load a show file from a USB memory stick. See section 17.6

Used to load a firmware update from a USB memory stick. See section 18.15

2.11 Reset Button

The (recessed) **RESET** button resets the operation of the Mantra Mini. All settings and configurations are retained.

3 Connection and Control Options

3.1 Overview

The Mantra Mini offers many possible connection and control options.

Power can be supplied by either:

- External 9-24 volts DC power supply
- PoE via the RJ45 Ethernet connector. *Note, PoE cannot be used if Wall Plates are connected to the W-COMMS connector*

A computer or tablet running the Mantra Editor software can be connected to program the Mantra Mini by either:

- Wi-Fi. The Mantra Mini has a built-in low range Wi-Fi access point. The computer or tablet running the Mantra Editor software connects directly to the Mantra Mini Wi-Fi
- Ethernet, preferably via a network router or switch with DHCP capability
- Wi-Fi client. The Mantra Mini Wi-Fi can be changed from access point mode to client mode and can connect to an existing Wi-Fi network. The computer or tablet running the Mantra Editor software connects to the same Wi-Fi network

Playback from the Mantra Mini can be controlled by either:

- Internal day/date time scheduler
- OSC, UDP or TCP commands via the Ethernet connector
- Contact closures connected to the 3 “Isolated Inputs”
- Wall plate switches connected to the W-COMMS connector (future feature)
- Mantra Mini can send messages to other devices by OSC, UDP or TCP commands

Mantra Mini can control up to 96 lighting fixtures across 2 DMX universes that are output as:

- Isolated DMX-1 connector
- Isolated DMX-2 connector
- Art-Net (ethernet connector)
- sACN (ethernet connector)

Mantra Mini can accept an input from a lighting console connected to either:

- Isolated DMX-2 connector configured as an input. See section 18.5.3
- Art-Net (ethernet connector)
- sACN (ethernet connector)

3.2 Installation Examples

The following are some typical examples of Mantra Mini installations. Many other combinations and configurations are possible.

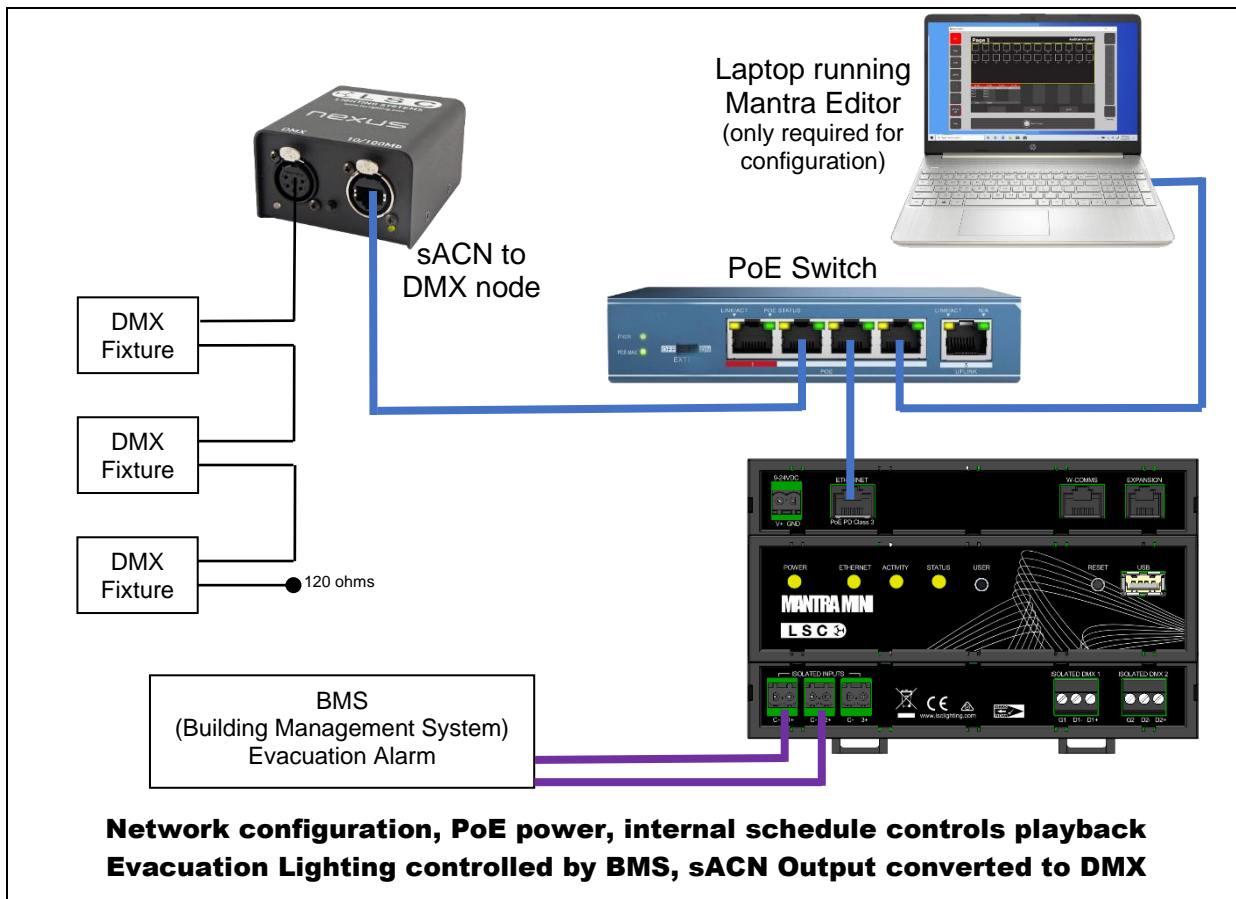
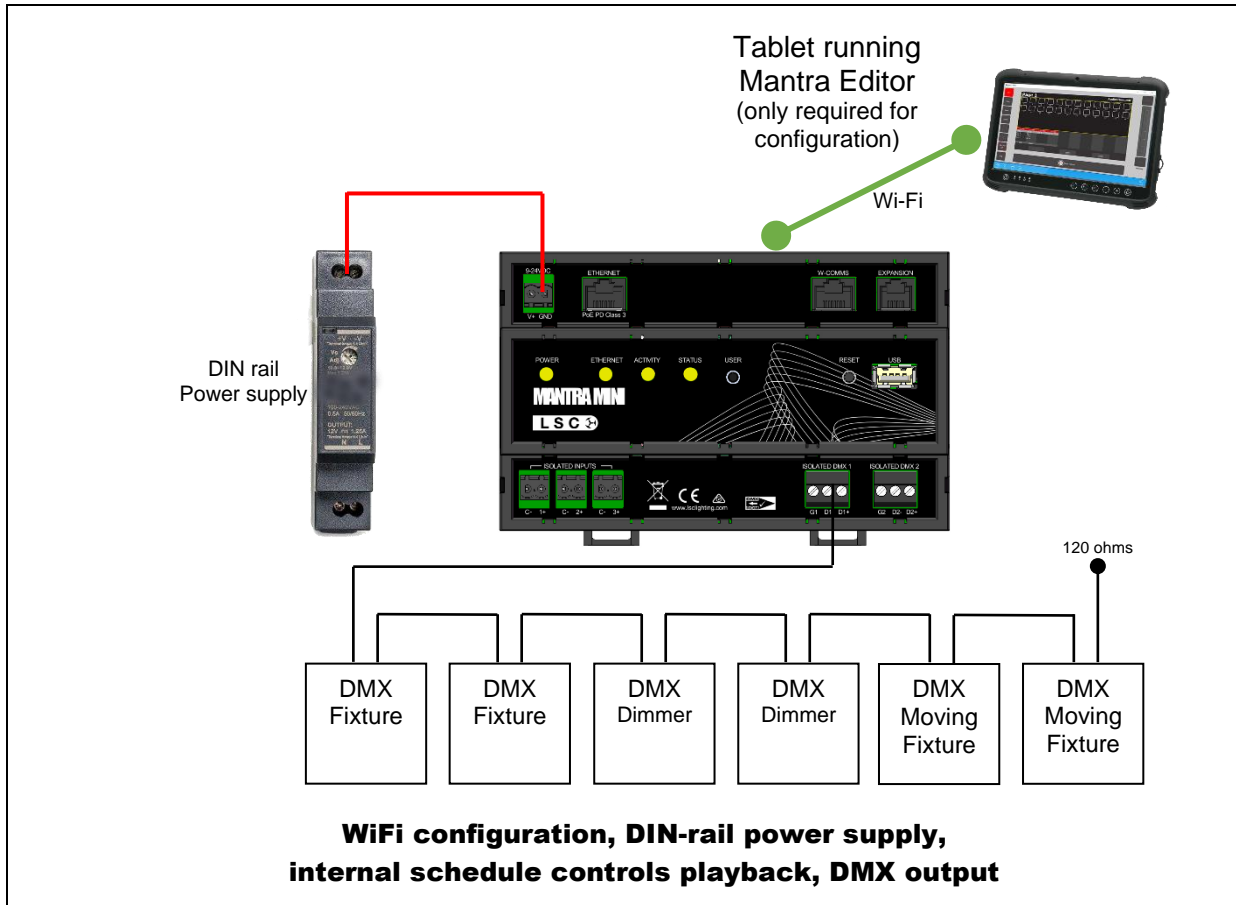

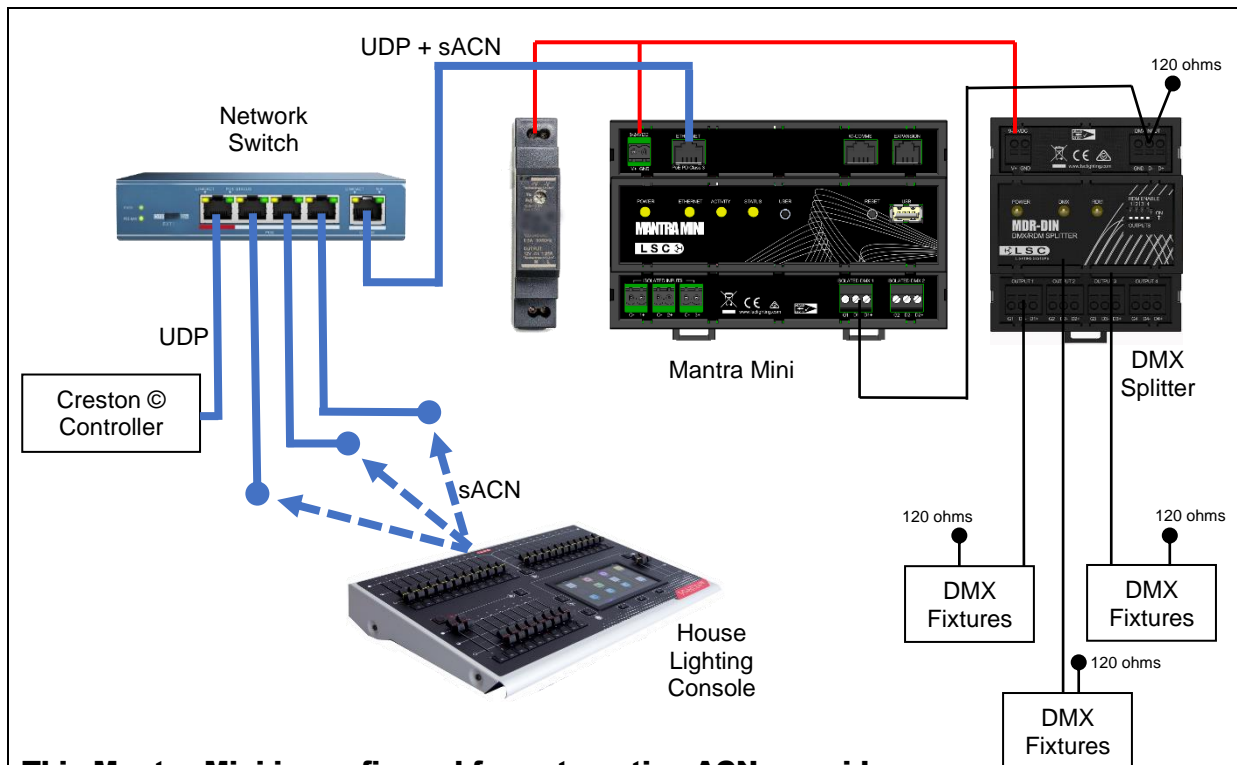

This Mantra Mini is configured for automatic sACN override.

- 1. When the Mantra Lite is not connected, the Crestron® Controller is used to send UDP messages to control the playback of Mantra Mini.**
- 2. The house lighting console can be patched into any data point around the venue and when the Mantra Mini detects the house consoles' sACN signal it gives it control of the lighting fixtures.**

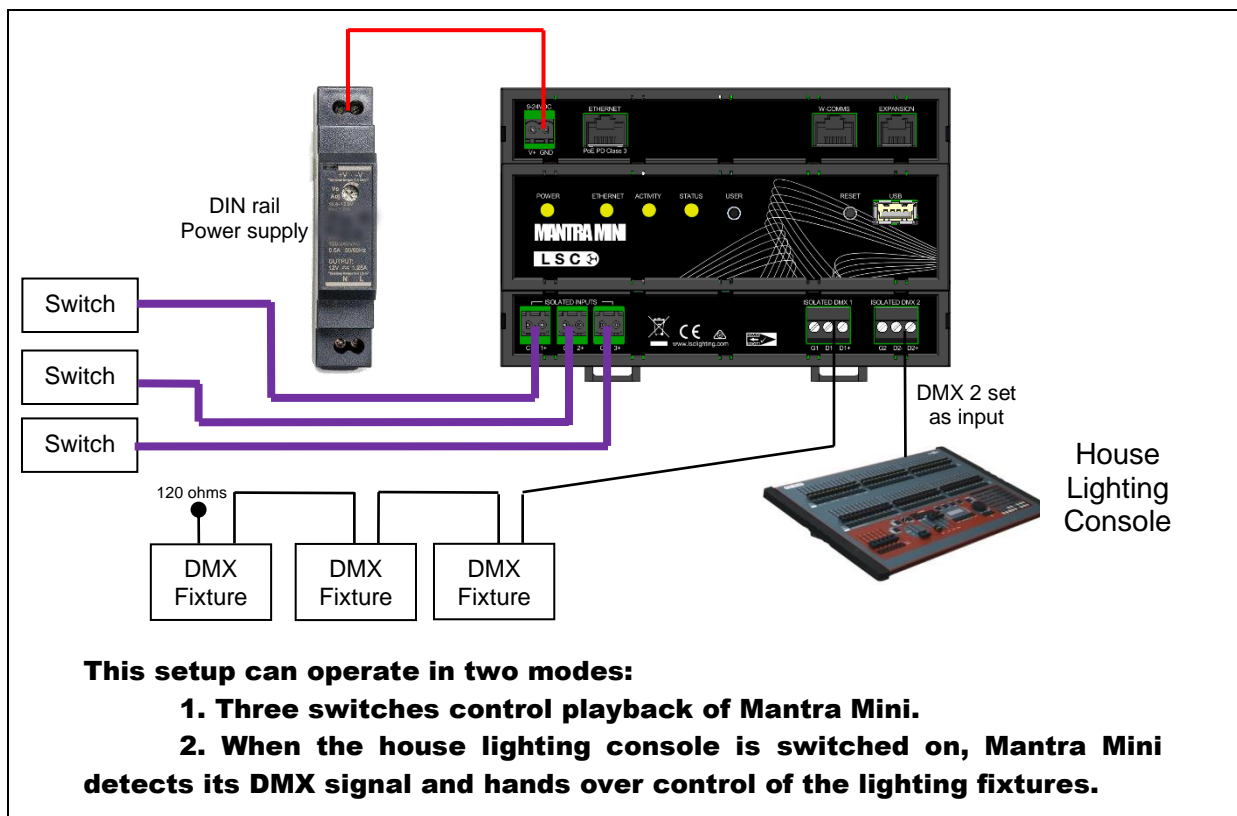

This setup can operate in two modes:

- 1. Three switches control playback of Mantra Mini.**
- 2. When the house lighting console is switched on, Mantra Mini detects its DMX signal and hands over control of the lighting fixtures.**

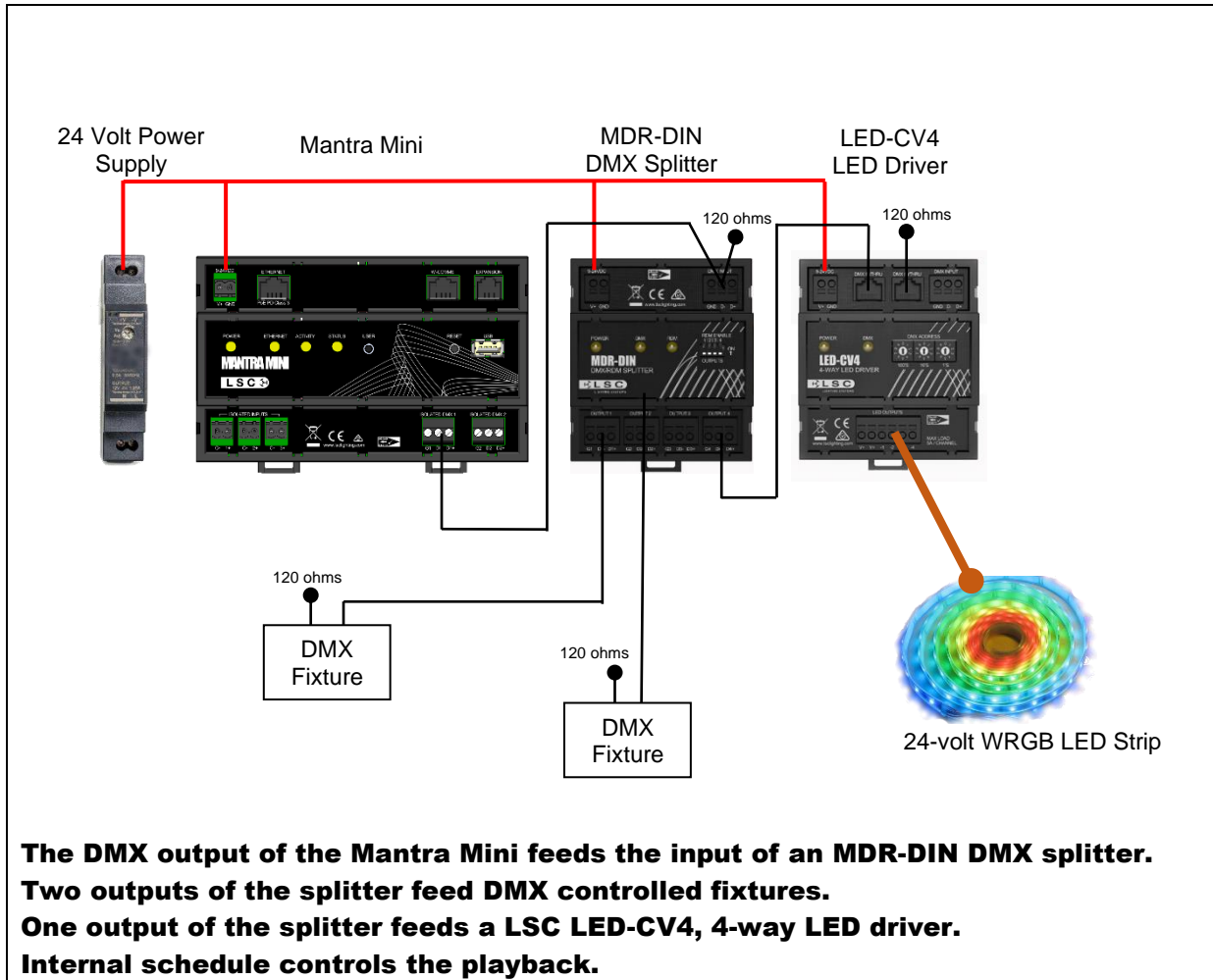

4 Front Panel LED's

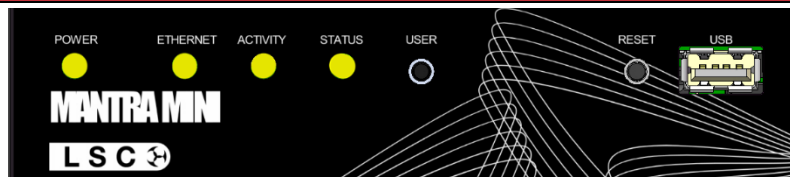

4.1 Power LED

Long flash, pause, repeat.
Double flash

Power is present
Clock has lost its time setting. See section 18.13

4.2 Ethernet LED

Off
Flashes

No network connection.
Network data is being transmitted or received.

4.3 Activity LED

Off
Flickers

No DMX, sACN or Art-Net is being transmitted.
DMX, sACN or Art-Net is being transmitted.

4.4 Status LED

On
Slow flash
Short flash, pause, long flash, pause etc
Fast flash
Rapid flash

Normal operation
Override active. See section 18.5.3
Mantra Editor software in control
Evac Mode is active
Error

4.5 USB Show Load Indication

If a USB stick containing a show file (in a folder named LSC) is inserted, all the front panel LEDs will triple flash for 5 seconds. Press the **USER** button before they stop flashing to load the show. See section 17.6

4.6 USB Software Update Indication

If a USB stick containing a software update file (in a folder named LSC) is inserted into the Mantra Mini, all the front panel LEDs will triple flash for 5 seconds. Press the **USER** button before they stop flashing to start the upgrade. See section 18.15

4.7 RDM Identify

If the Mantra Mini receives an RDM "Identify" command, the four LEDs on the front panel flash in pairs (left pair then right pair).

5 QuickStart Guide

5.1 Overview

The Mantra Editor software is used to programme the Mantra Mini. It emulates the powerful Mantra Lite lighting console but includes the additional features of the Mantra Mini such as the real time scheduler and remote trigger programming. Shows created on a Mantra Lite console can also be opened on the Mantra Editor, edited and saved onto the Mantra Mini.

Once the Mantra Mini has been programmed, playback can be either internally controlled by a day/date time “Schedule” or by “Remote Triggers” in the form of OSC, UDP or TCP commands over ethernet or contact closures on the 3 isolated inputs.

5.2 Install the Mantra Editor Software

The Mantra Editor software is available from “mantramini.lsccontrol.com.au”. Download and run the Mantra Editor Setup program on your computer or tablet.

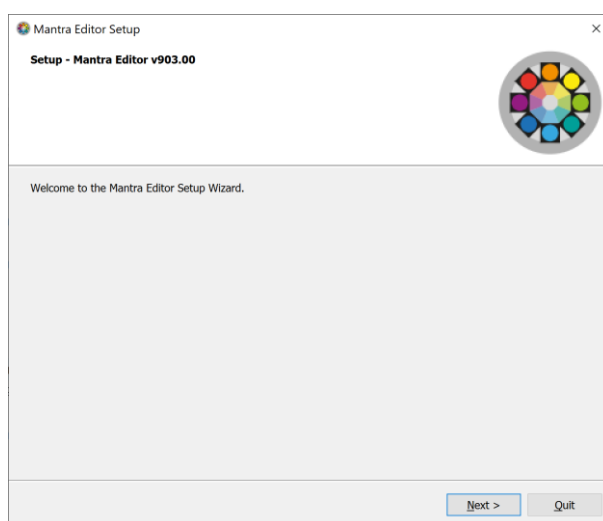

Follow the on-screen instructions and be sure to allow Mantra Editor access through your computers firewall. Run the Mantra Editor program.

5.3 Programming Mantra Mini with the Editor

The computer or tablet running the Mantra Editor can be connected to the Mantra Mini by either Wi-Fi or by Ethernet. LSC recommends that your first connection to the Mantra Mini is via Wi-Fi because this is the quickest method of connection. See section 5.4

The lighting cues to be played back by the Mantra Mini are saved in a show file that is saved in the Mantra Mini. Show files can also be saved in the Mantra Editor (the computer running the Mantra Editor) for back-up or off-line editing.

When loading or saving show files,

- Select “View Local” to access the Mantra Editor
- Select “View Remote” to access the Mantra Mini

See section 5.4 for more information about “View Local” and “View Remote”.

The Mantra Editor takes control of the Mantra Mini output whenever you,

- Save a show file to the Mantra Mini
- Load a show file from the Mantra Mini

The Mantra Editor is then used to control the lighting fixtures allowing you to see their output, create the desired lighting looks and to record those looks as lighting cues in the show. See “Output Priority” below for more details.

The cues can be checked (and edited if necessary) by playing them back using the Mantra Editor. The Mantra Editor is then used to program how the Mantra Mini will playback the cues. Playback can be performed by either the “scheduler” in Mantra Mini or by isolated inputs (contact closures), or OSC, UDP or TCP network commands.

When programming is completed, the Mantra Editor program is closed and after a brief pause, the Mantra Mini automatically resets and takes back control of its output.

5.3.1 Output Priority

The Mantra Mini consists of a playback section and an output section:

- The “playback” section contains the show file with the lighting cues and the controls that determine when those cues are to be played back.
- The “output” section generates the DMX, sACN and ArtNet output signals that control the lighting fixtures. The data that generates the DMX, sACN and ArtNet output signals can come from 3 different sources that are selected by the “automatic switch” as described below.

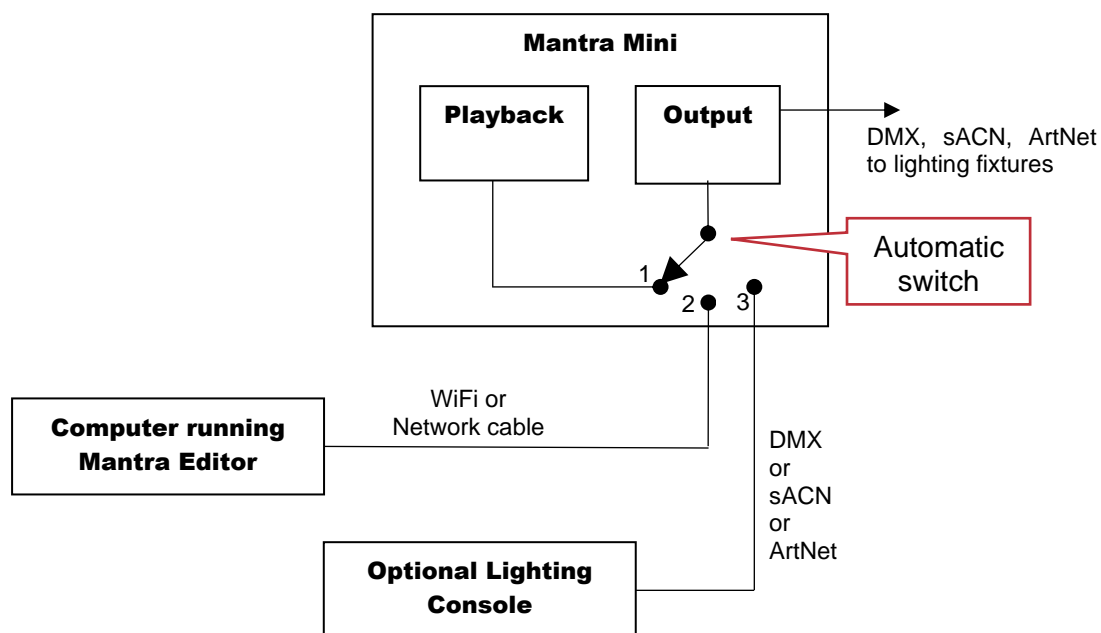

“Simplified” Output Signal Sources

1. During normal operation (when the Mantra Editor is not connected), the automatic switch is in position 1 and the “Playback” section of the Mantra Mini is connected to the “Output” section and controls the fixtures. Playback is performed by either the “scheduler” in Mantra Mini or by isolated inputs (contact closures), or OSC, UDP or TCP network commands or by LSC Wall-plates (wall-plates are a future feature).

2. When a computer or tablet running the Mantra Editor is connected to the Mantra Mini and a show file is either saved to or is loaded from the Mantra Mini, the automatic switch moves to position 2 and the Editor is connected to the “Output” section and controls the fixtures. This allows you to see exactly what you are programming on the lighting fixtures. When all of the lighting cues and configuration are correct, you save the show to the Mantra Mini’s playback

section. When the Mantra Editor is disconnected, the switch automatically moves back to position 1 and the playback section controls the output.

3. If one of the Mantra Mini's "Inputs" (sACN, ArtNet or DMX) has been "activated" and the Mantra Mini detects the specified sACN or ArtNet universe or the DMX input signal, the automatic switch moves to position 3 and that input signal is connected to the "Output" section. This allows an external lighting console to control the Mantra Mini's fixtures and is known as "override" mode. See section 18.5.3

Note: If the Editor has control (position 2) it has precedence over the "Input" override signal (position 3).

5.4 Connecting the Editor to the Mantra Mini via Wi-Fi

Follow these steps to connect the Editor to the Mantra Mini Wi-Fi.

1. Mantra Mini has short range inbuilt Wi-Fi Wi-Fi Access Point. Open your computers Wi-Fi settings and connect it to the Mantra Mini's Wi-Fi.

The name of the Mantra Mini Wi-Fi is "MantraMini_####" (where #### is an exclusive number for every Mantra Mini)

The security key is "mantra_mini".

If there are multiple Mantra Minis in your installation make sure you select the desired one. The easiest way to identify the desired Mantra Mini is to remove the power from the other Mantra Mini's. If the Mantra Mini is mounted inside a metal cabinet you might have to open the door to make a Wi-Fi connection.

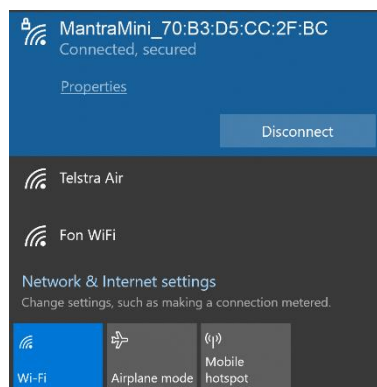

When using Microsoft Windows to connect to a Mantra Mini, you must set your computers network profile to "Private".

After connecting you might see the following message. Select "Yes".

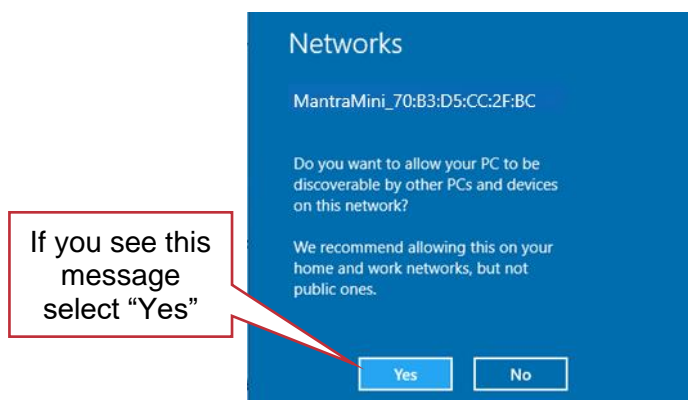

Alternatively, to manually change the network profile to “Private”, click the available Network icon in the Notification area.

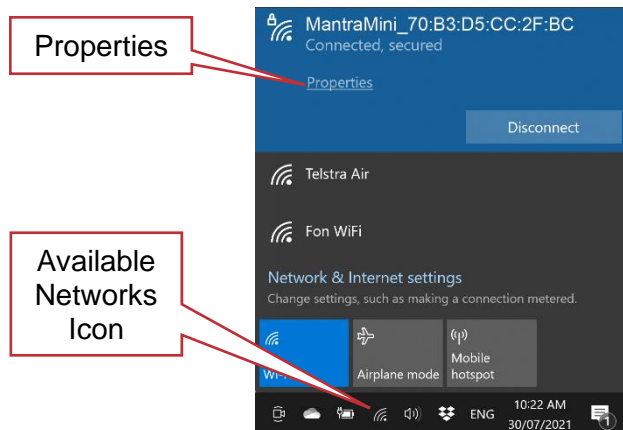

Select the Mantra Mini network and then click **Properties** and in the “Network profile” that opens select **Private**.

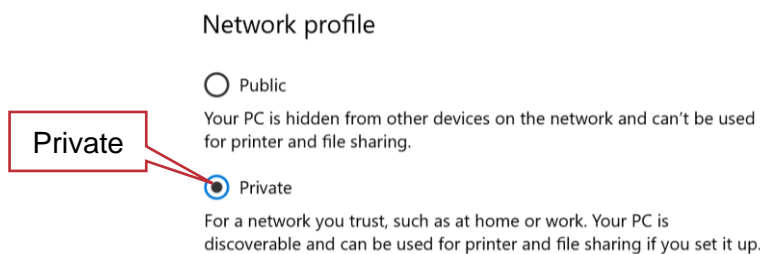

2. With the computer now connected to Mantra Mini’s Wi-Fi Access Point, open the Mantra Editor application on your computer. To use the Wi-Fi connection, click **Tools, Setup, System Settings**. In the “Available Networks” pane click on **WiFi** then double click **Back/Home**.
3. To control the Mantra Mini’s fixtures, create a new show and save it to the Mantra Mini by clicking **Tools, New Show, Tools, Save Show**, enter a **name** for the show then click **View Remote**, click the **MMD (Mantra Mini Device) Icon**. Click **Save**. The editor now controls the output of the Mantra Mini.

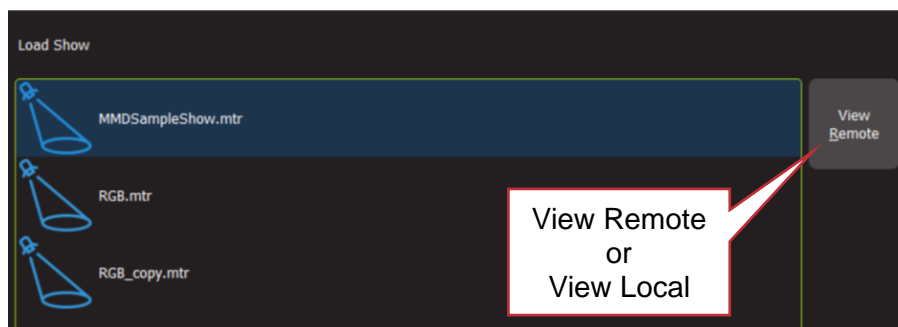

***Hint:** When the Mantra Editor is connected to the Mantra Mini, the top of the home screen on the Mantra Editor shows the Network Name of the Mantra Mini followed by the show name. In the following example, the Mantra Mini’s “Network Name” has been set to “Foyer MM”. When the Mantra Editor is connected to the Mantra Mini, “Foyer MM:::/” is shown before the show name.*



When the Mantra Editor is NOT connected to the Mantra Mini, only the show name is shown.



Note: Multiple Mantra Minis can exist on the same network. When you click “View Remote”, each Mini is shown as a Mantra icon  and a unique name. Click on the Mantra icon that you require.

Hint: To save time you can perform some fixture patching and programming and save the show on the editor prior to connecting the editor to the Mantra Mini. When on site and within Wi-Fi range of the Mantra Mini, perform steps 1 and 2 above and then “load” the previously created show into the editor and then “Save Show As” to the Mantra Mini.

For more information on show files see section 17.

5.5 Connecting the Editor to the Mantra Mini via Ethernet

The Mantra Mini’s default ethernet setting is DHCP (Dynamic Host Configuration Protocol). DHCP is used to automate the process of configuring devices on IP networks. In order to have a network address automatically assigned, the Mantra Mini must be connected to a DHCP server. Most consumer routers are set up to act as a DHCP server and will automatically assign an IP address to the Mantra Mini.

When using Microsoft Windows to connect to a Mantra Mini, you must set your computers network profile to “Private”. To change the network profile for a wired network, click **Start, Settings, Network & Internet, Ethernet**, then click your network adapter and choose the “Private” profile.

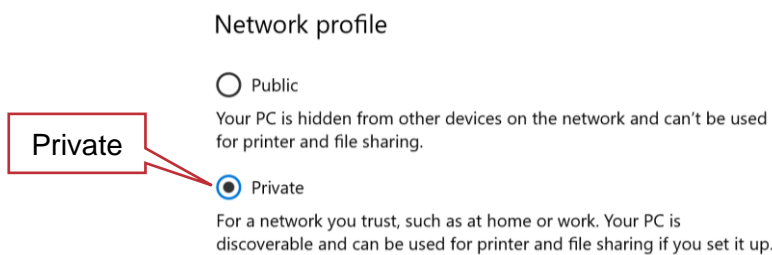

Follow these steps to connect the Editor to the Mantra via ethernet.

1. Connect the Mantra Mini and the computer or tablet running the Mantra Editor to the same DHCP server.
2. Re-boot the Mantra Mini by pressing its **RESET** button.
3. Open the Mantra Editor application. To use the ethernet connection, click **Tools, Setup, System Settings**. In the “Available Networks” pane click on **Ethernet** then double click  **Back/Home**.
4. To control the Mantra Mini’s fixtures, create a new show and save it to the Mantra Mini by clicking **Tools, New Show, Tools, Save Show**, enter a **name** for the show then click

View Remote, click the Mantra Mini **Icon**. Click **Save**. The editor is now connected to the Mini and controls its output.

Note: If a DHCP server is not available you can connect the Mantra Mini using Wi-Fi and when connected, set a static IP address in the Mantra Mini. See section 18.8. Alternatively, LSC's HOUSTON X software will find the Mantra Mini when connected by ethernet and can then be used to set a static IP address. See section 22.

To edit a show that has already been saved on the Mantra Mini, click **Tools, Load Show, View Remote**. Click the Mantra Mini **icon** then click on the show file **name** then click **Load**.

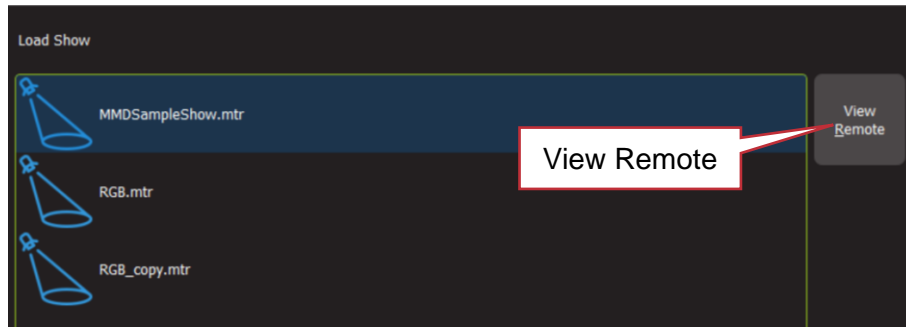

Note: Multiple Mantra Minis can exist on the same network. When you click “View Remote”, each Mini is shown as a Mantra icon  and a unique name. Click on a Mantra icon to access its contents.

5.6 Disconnecting the Editor from the Mantra Mini

The Mantra Editor is disconnected from the Mantra Mini when any of the following are performed,

- A show is saved to the (Local) Mantra Editor
- A show is loaded from the (Local) Mantra Editor
- A “New Show” is opened in the Mantra Editor
- The Mantra Editor program is closed

5.7 Basic Programming Steps

The following are the basic steps to program and playback a show on the Mantra Mini. Detailed descriptions of each step are contained later in this manual.

5.7.1 Step 1. Patch the Fixtures

Mantra Mini needs to know the DMX address and type/mode of each fixture that is connected to its output. Each fixture is patched to a fixture number. See section 7.

5.7.2 Step 2. Control the Fixtures

Hint: If you want the Mantra Editor to control the actual fixtures that are connected to the Mantra Mini, save the show to the Mantra Mini.

Click **Tools, Save Show As, View Remote**. Click the **Mantra Mini Icon**, enter a name for the show then click **Save**. See sections 5.3 and 17.3.

To control a patched fixture using the Mantra Editor, click its numbered fixture **icon** (the number turns yellow). Multiple fixtures can be selected.

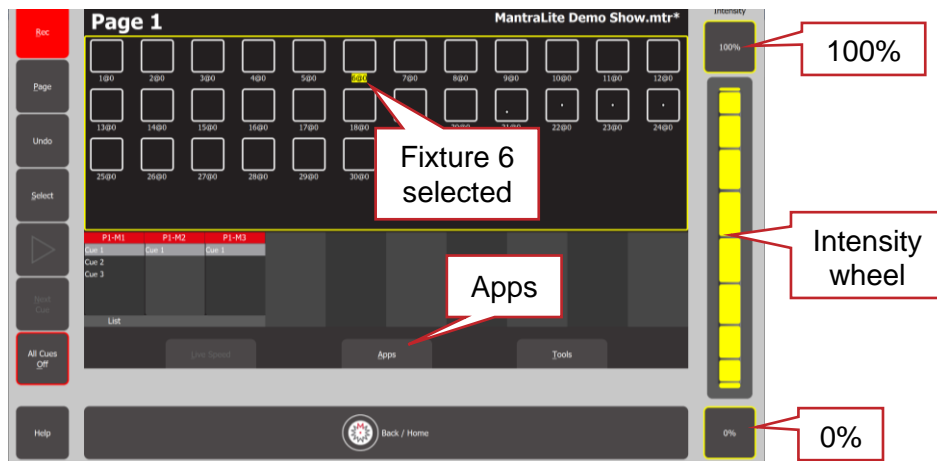

- To adjust the intensity, click and scroll the “Intensity” wheel or click the **100%** or **0%** buttons.
- To control the other attributes of a fixtures, use an App. There are Apps for colour, position, beam, animations and shapes. Click **Apps** to open the “Apps ”screen. Click the appropriate **App** (colour, position or beam) then adjust the attribute. See section 6 “Quick Tour” and section 9 “Controlling Fixtures” for more details.

5.7.3 Step 3. Record the Output as a Cue

When you have adjusted the intensity and colour of your fixtures and possibly created animations or shapes, the current output can be recorded into as a “cue” for later playback. To record the current output, click **Rec** then click the Playback displayer of your choice (1-10).



Each playback can contain a single cue or a cue-list. To record a cue-list, create the next lighting look on the output then record to the same Playback number. Multiple cues and cue-lists can be recorded. 10 pages of playbacks are available. See section 12 for more details.

5.7.4 Step 4. Playback and Check

Clear all fixtures back to no intensity and default attribute values by clicking **Apps, Clear All**. Click on the **playback displayer** of the cue or cue-list to be played. To fade up or fade down the cue click ►. To crossfade to the next cue in a cue-list click **Next Cue**.

5.7.5 Step 5. Edit

If necessary, edit the fade times, intensities, animation speeds etcetera. See section 14.

5.7.6 Step 6. Program the Playback

Playback can be controlled by either,

- Day/date time schedule. See section 15

- Remote Triggers. Contact closures (isolated inputs) or OSC, UDP or TCP network commands. See section 16

5.7.7 Step 7. Save the Show

When you have finished programming, save the show to the Mantra Mini so that it can be played back when the computer is not present. Click **Tools, Save Show As, View Remote**. Click the **Mantra Mini Icon**, enter a name for the show then click **Save**.

Hint: Save the show to the Mantra Mini often during the programming process.

5.7.8 Step 8. Disconnect the Editor

When the Mantra Editor connection is removed, the Mantra Mini automatically resets and then takes back control of its output. Playback is then performed by either the “scheduler” in Mantra Mini or by Remote Triggers.

6 Mantra Editor Quick Tour

6.1 Overview

This section gives a very brief overview of the Mantra Editor and the basic steps required to control fixtures and record cues. Full descriptions of each step are described in the following sections.

6.2 Home Screen

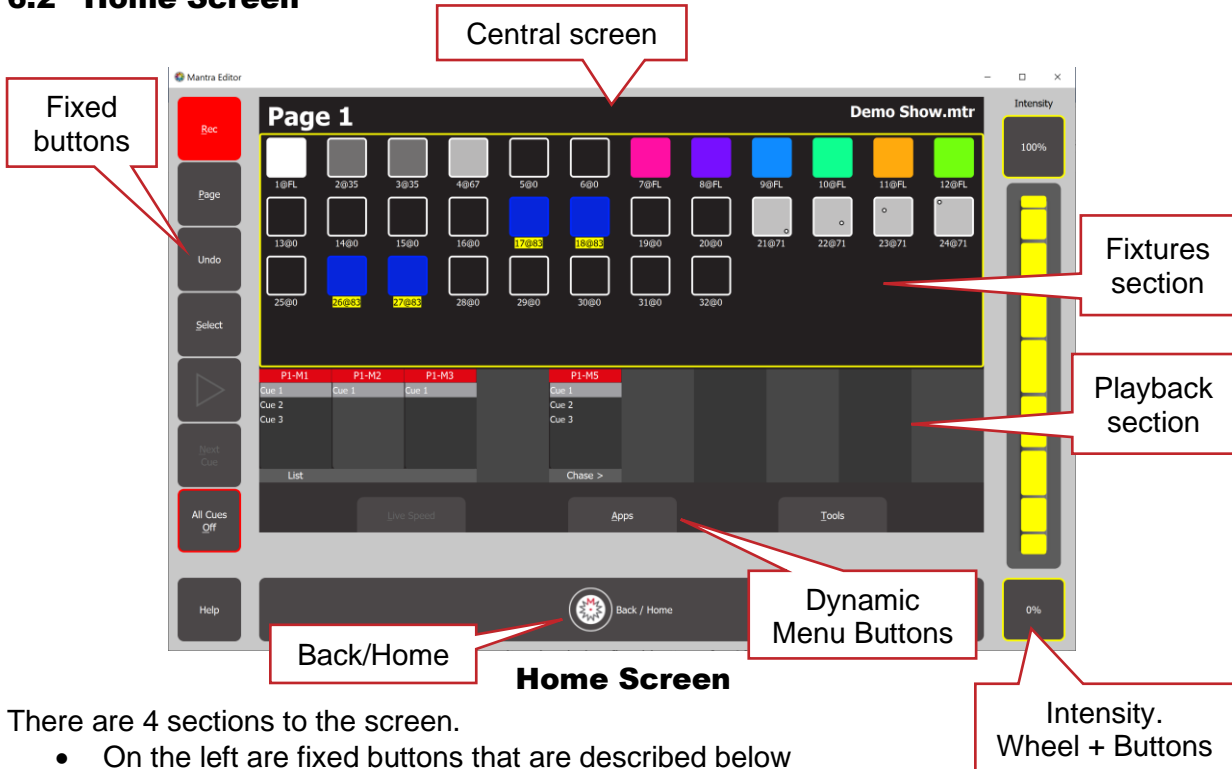

There are 4 sections to the screen.

- On the left are fixed buttons that are described below
- On the right is the Intensity wheel plus fixed buttons for 0% and 100% intensity
- The central screen displays the various screens that can be selected by the dynamic menu buttons at the bottom or the fixed buttons on the left.
- At the bottom is the Back/Home button.

When you are navigating through the various screens, clicking **Back/Home** steps the central screen back through the screens to the “Home” screen.

Double clicking **Back/Home** returns immediately to the “Home” screen from any screen.

The “Home” screen (shown above) is divided into two sections:

- The Fixtures section at the top (surrounded by a thin yellow border) has a Fixture icon for each patched fixture
- The Playback section at the bottom has 10 Playback displayers. Cue information appears in a Playback displayer when a recording has been made in that playback.

Some screens have sliders to adjust values. When you click on a slider you can drag the slider and even let the mouse drift off the slider as long as you keep the mouse button down. If you click on the background area of the slider it will snap to your position.

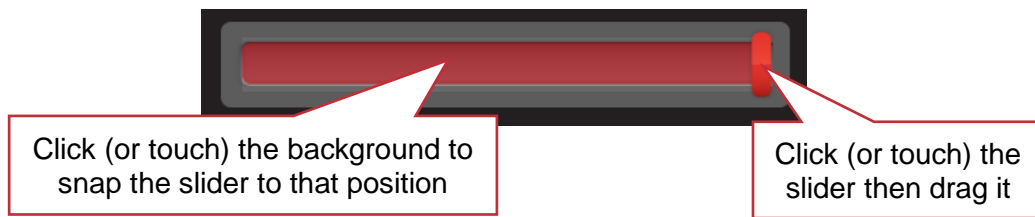

You can also hover the mouse over the slider then scroll the mouse wheel.

Hint: All events are triggered when you release the mouse button (or lift your finger from a touch screen).

The top section of the “Home” screen has an icon for each of patched fixture.

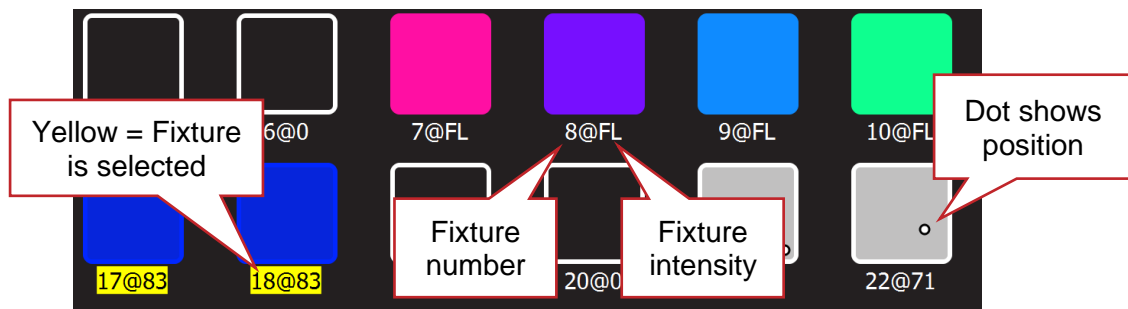

Fixture Icons

- Below each fixture icon is its fixture number and its intensity (FL=Full)
- “Selected” fixture numbers have a yellow background
- The body of each icon also shows the intensity of the fixture, dark to bright
- The body and border show the colour mixing (if the fixture has colour capability)
- A dot shows the position (if the fixture has a pan/tilt function)

Note: The colour of the icon represents colours created by RGB (Red, Green, Blue) or CMY (Cyan, Magenta, Yellow) colour mixing in the fixture. Colours created by colour wheels or filters are not shown.

6.2.1 Selecting Fixtures.

Clicking a fixture icon selects that fixture (its number background turns yellow) allowing its intensity to be controlled (see below) and its other attributes (colour, position etcetera) to be controlled by clicking **Apps** (see sections 6.3). Click a selected fixture again to de-select it. For more options on selecting fixtures see section 9.

Hint: Clicking and holding any fixture icon for 2 seconds opens “Rig View” allowing you to rearrange the positions of the icons. See section 8.

6.2.2 Controlling Intensity

To the right of the screen are the intensity controls. They become active whenever a fixture(s) is selected. To control the intensity of the selected fixture(s) either,

- Click and drag the “Intensity” wheel
- Hover your mouse above the intensity wheel and scroll the mouse wheel
- Click the 100% or 0% buttons

See section 9.2 for additional methods of controlling intensity.

6.2.3 Fixed Buttons

The buttons on the left of the screen are:

Select

This opens the “Select” screen which provides another means of selecting fixtures including a list of previous selections, selecting a range of fixtures and reversing the selected order.

Rec

To record the current output, click **Rec** then click the Playback displayer of your choice (1-10). Flashing red boxes indicate that a recording can be made. To record a cue-list, create the next lighting look on the output then record to the same Playback number.

Page

Repeated clicks of the **Page** button will step through the 10 pages of playback memory. There are 10 playback controls and 10 pages of memory giving a total of 100 playbacks/memories. Each memory can contain a single cue or a “Cue-list” that contains up to 250 cues. The current page number is shown at the top of the Home screen.

Undo

Double click to undo the last action. See section 6.6.

Help

Context sensitive help is available on for most screens/functions. Click **Help** to open the help screen. Click **Help** or **Back/Home** to close.



If a playback displayer contains a cue or cue-list, clicking that playback’s displayer opens its “Edit memory” screen. Clicking , fades the cue (or cue-list) up or down.

Next Cue

If a playback displayer contains a cue-list, clicking that playback’s displayer opens its “Edit memory” screen. Clicking **Next Cue**, crossfades to the next cue in the cue-list.

6.3 Apps

On the “Home” screen, clicking **Apps** (or pressing **A** on the computer keyboard) opens the “Apps” screen.

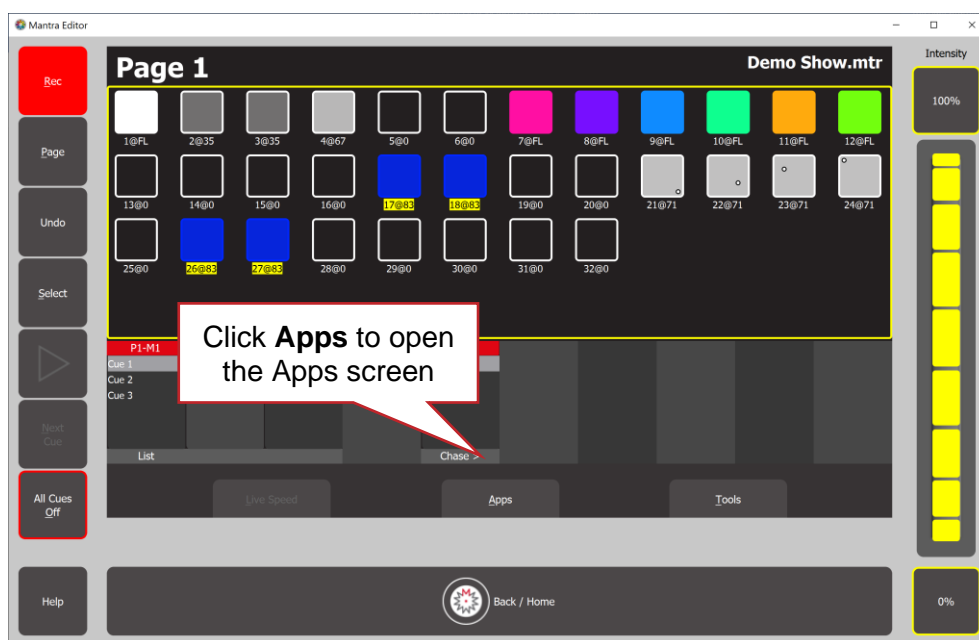

Home Screen

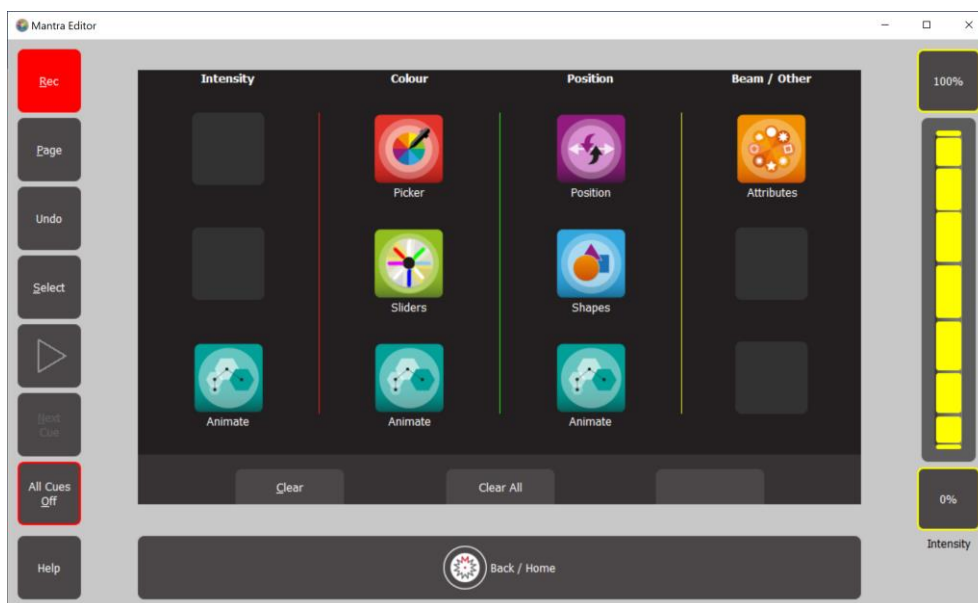

Apps Screen

Apps are used to control the attributes (colour, pan/tilt, shutter etcetera) of the selected fixtures.

The “Picker” app allows you to control the colour of selected fixtures (that have colour capability) and to “fan” colours across multiple fixtures. The “Sliders” app allow provides individual sliders for all colours of the selected fixtures. See section 9.4.

The “Position” app allows you to control the pan and tilt position of selected fixtures (that have position capability) and to “fan” positions across multiple fixtures. See section 9.5.

The “Animate” apps allow you to create intensity chases, colour chasses and patterns, moving beam effects. See section 10.

The “Shapes” app provides a quick and simple way of creating continuously moving beam positions. See section 11.

The “Attributes” app allows you to control all beam attributes such as “Gobo”, “Colour Wheel”, “Shutter” etcetera plus any other attributes of the selected fixture that are not in the colour or position Apps. See section 9.6.

6.4 Clearing Fixtures

When you select a fixture and adjust its intensity or use an App to change the colour, position or beam attributes, the settings that you create for the fixtures are remembered in Mantra Editors “Live Memory”.

Whenever you are starting to program a new lighting look, it is standard practice to clear the Live Memory and therefore restore fixture(s) to their default settings (no intensity, open, white, centred beam) as well as delete any animations or shapes running in the live memory.

To clear the “Live Memory”, from the “Home” screen click **Apps, Clear All**.

Recorded cues are not affected by “Clear All”.

*Hint: Whenever you want to start creating a new lighting look or if you have any unexplained output from the Mantra Mini click **Apps/Clear All** (keyboard shortcut **A** then **L**) and **All Cues Off** (keyboard shortcut **O**).*

6.5 Playback Displayers

The bottom section of the “Home” screen has playback displayers that show the contents of the Playbacks. Cue numbers appear in playbacks when a cue is recorded into a Page/Memory.

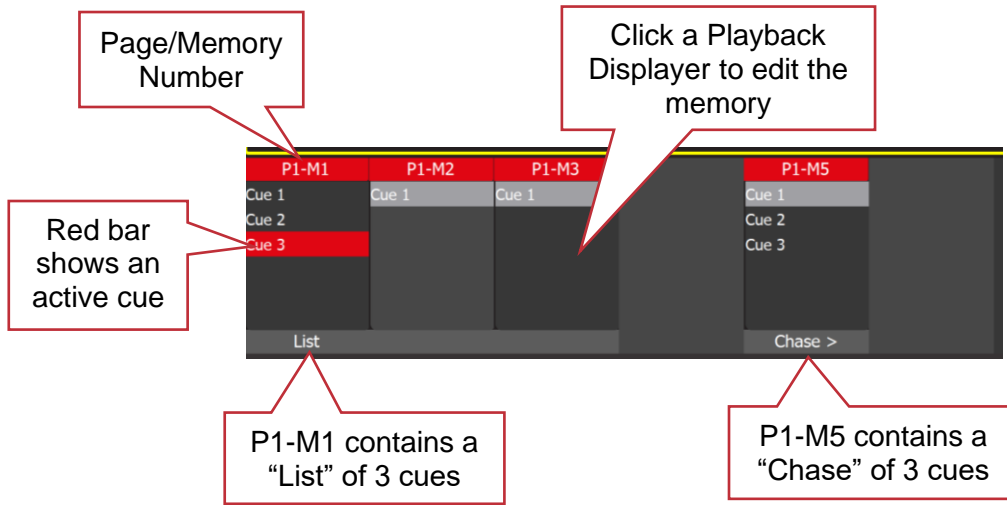

There are 10 pages of memory, P1 to P10.

Repeated clicks of the **Page** button will step through the 10 pages of memory.

There are 10 memories (playbacks) on each page, M1 to M10 (from left to right).

Each memory can contain a single cue or a list of up to 250 cues that can be played back as either a “List” (manually play each cue) or as a “Chase” (automatically steps through the list).

The top part of each playback displayer shows the page/memory number in the form of: “P#-M#” (Page number, 1-10 and Memory number, 1-10).

Hint: You can change the name of each “Page/Memory number” and the name of each “Cue number” and replace them with more descriptive names by “Editing” the memory. See section 14.

Clicking any playback displayer opens its “Edit Memory” screen....

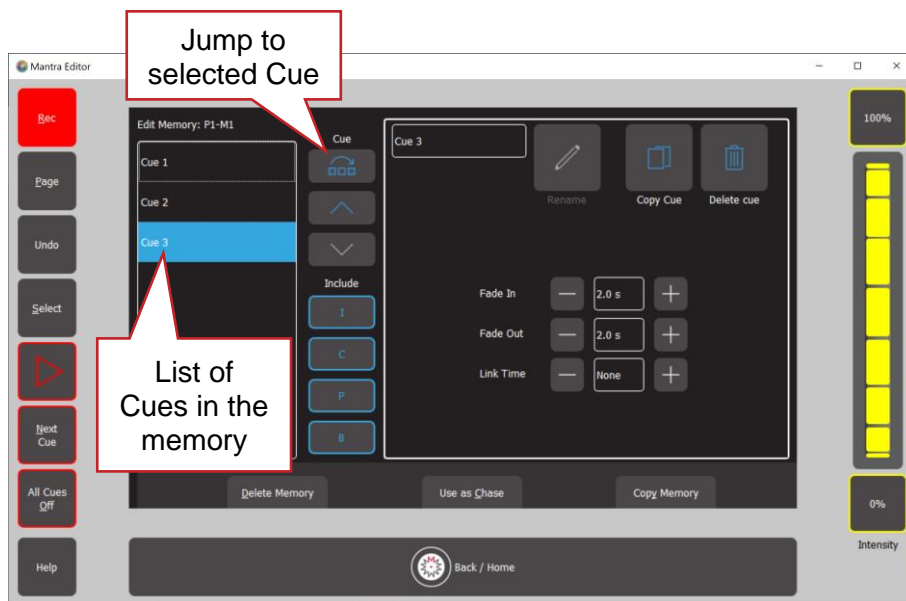

Edit Memory: P1-M1 (Page 1 - Memory 1)

Click a cue to select/de-select it. Multiple cues can be selected.

Using this screen, you can,

- Playback the cue. The ► (Play) and **Next Cue** buttons are active when editing a playback memory. Clicking ►, fades the cue (or cue-list) up or down. If a playback contains a cue-list, clicking **Next Cue**, crossfades to the next cue in the cue-list
- Select a single Cue then directly **Jump To** that cue using the recorded fade times. This is most useful if you have a long cue-list and you want to quickly playback a cue without stepping through all of the intermediate cues
- Re-order the selected cue(s) using the ^ or v buttons
- “Include ICPB”. When a memory is recorded it includes all of the Intensity, Colour, Position and Beam (I C P B) attribute groups. Clicking an attribute group (I C P B) excludes that group from the playback. The selection applies to all cues in the cue-list. This is a very powerful function. See section 14.10
- Change the “Fade In” and “Fade Out” times of the selected cues
- If the memory contains a cue-list you can set the “Link Time” of each cue (automatically plays the next cue after the link time expires)
- Re-name the memory
- Re-name the selected cue
- Copy the selected cue
- Delete the selected cue
- Copy Memory (all cues in the list)
- Delete Memory (all cues in the list)
- Use the list as a chase or a cue-list

For more details on the functions above and also how to edit the contents (intensity, colour, position etcetera) of a cue see section 14.

6.6 Undo

To quickly undo your last action double click Undo.

All of your actions are tracked and stored in the “Undo/Redo History” screen. Click **Undo** once to see the list of your actions.

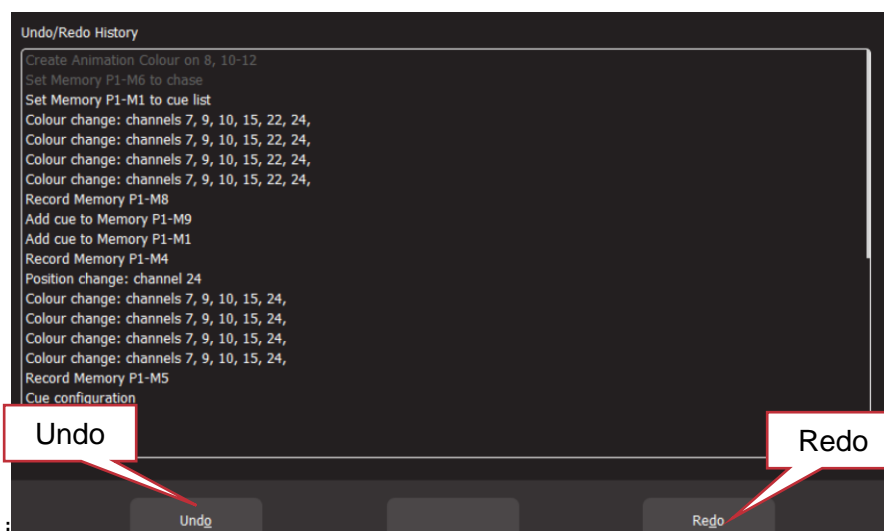

- Click **Undo** to undo an action and step down the list.
- Click **Redo** to redo an action and step up the list

Actions that have been undone turn grey.

This enables you to retract or reinstate programming at any point of programming a show.

Click **Back/Home** when finished.

Note: The undo list is automatically cleared whenever you save your show, start a new show, load an existing show or close the Mantra Editor program.

Note: The “Undo” function is not available when editing “Rig View” (section 8), when using the “Fixture Editor” (section 19) or when deleting a memory (section 14.12).

6.7 Keyboard Shortcuts

Many functions of the Mantra Editor can be performed by a keyboard shortcut button. You can experiment to find buttons that work as shortcuts on the various screens of the Mantra Editor.

The following are some of the most useful shortcuts.

- To go back one screen press **Esc** (equivalent to  **Back/Home**)
- To clear All fixtures in the “Live memory”, from the Home screen press **A** then **L**
- To turn Off all active cues, from the Home screen press **O**
- To open the Apps screen, from the Home screen press **A**
- To save the show (Tools/Save), from the Home screen press **T** then **S**

7 Patching Fixtures

7.1 Overview

The output control signal from the Mantra Mini is known as DMX512-A. It is an international standard for controlling lighting equipment. The DMX signal is output on DMX connectors and also on the Network connector as either Art-Net or sACN protocols.

Your lighting fixtures and dimmers have a DMX input and usually a DMX output so that you can connect multiple devices in a daisy chain fashion. You set an address on each fixture and use Mantra Mini to control each fixture based on its address. Each fixture will use a quantity of DMX channels to control its different functions as listed in its specifications. The address that you choose for each fixture must allow for the addresses used by other fixtures so that no overlaps exist. For example, fixture 1 is set to address 001 and this fixture uses 4 DMX channels. Fixture 2 must be set to address 5 (or higher).

Fixtures patched to U1 (Universe 1) have their DMX output on the “Isolated DMX1” connector and can also be output on any sACN or ArtNet universe. See section 18.5.

Fixtures patched to U2 (Universe 2) have their DMX output on the “Isolated DMX2” connector and can also be output on any sACN or ArtNet universe.



Note: It is possible to set “Isolated DMX2” as an input. In this case, only “Isolated DMX1” is available as an output. See section 18.5.3.

Mantra Mini includes a fully integrated fixture library of over 5500 fixtures (most with multiple operating modes) supplied by Carallon, an independent supplier of fixture libraries.

If you do encounter a fixture that is not in the library you have two choices:

1. A fixture request service is available via the LSC web page. This process takes at least one month from the date of request.
2. The Fixture Editor in the Mantra Editor allows you to quickly create a template for a new fixture. See section 19.

To patch a fixture, in the “Patch” screen you tell Mantra the manufacturer/model and DMX address of each of fixture it is controlling. You patch it to a fixture number (1 to 96) as described below. Mantra makes the patch and loads a “template” for that manufacturer/model of fixture from its fixture library. The template tells Mantra how to control that fixture.

Once a fixture is patched, when you select that fixture, the intensity wheel and intensity buttons control its intensity and the Apps screen provides the correct controls for the other attributes of that fixture. For example, if the fixture is a multi-coloured LED, Mantra Editor provides a colour picker App to control the colour. If the fixture has pan and tilt capabilities Mantra Editor provides a position App to control the position.

You can patch multiple fixtures in a single operation, patch multiple fixtures of the same type but with different DMX addresses to the same fixture number, delete patches and view the patch as described in the following sections.

The patch is saved (and recalled) when you save (or load) a show file.

7.2 Patching a fixture

7.2.1 Brief Description

In the “Patch” screen:

- Select the “Manufacturer” and “Model” of the fixture
- Enter the Universe number (1 or 2)
- Enter the DMX address of the fixture
- Click **Patch** then choose a fixture number (1 to 96).
- Click Back/Home to finish.

7.2.2 Detailed Description

Identify the manufacturer and model of the fixture to be patched and set or take note of its DMX address.

To patch that fixture, from the “Home” screen click **Tools, Setup, Patch**.

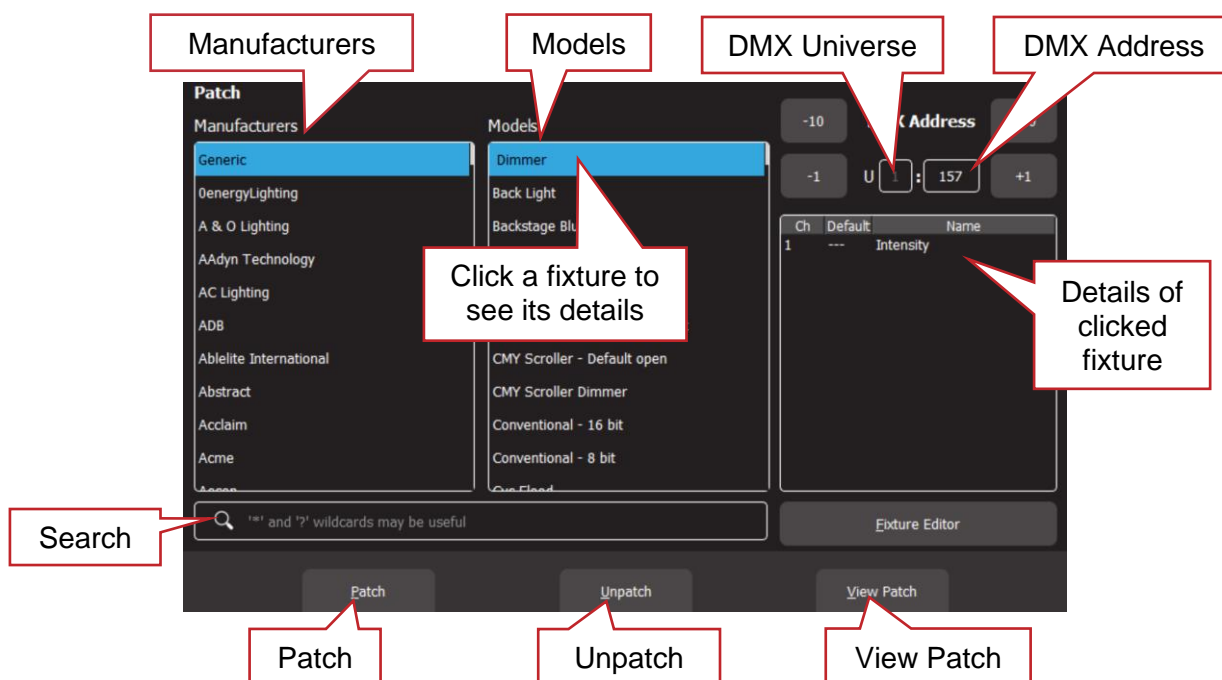

Find the Fixture Manufacturer by scrolling the left hand “Manufacturers” pane (or use the search function) and click the **Manufacturer Name**.

Hint: Dimmers and many LED fixtures can be found in the “Generic” manufacturers listing.

Find the specific fixture Model by scrolling the middle “Models” pane (or use the search function) and click the **Model Name**.

You can click the “Search” icon and type in a manufacturer or model name using the pop-up keyboard. The symbol (*) can be used as a substitute (wild card) for any string of characters in your search term. You can also use the symbol (?) as a substitute for one character.

When you click a fixture model, the details of the DMX channels for that fixture (as contained in the Mantra Mini fixture library) are shown on the right.

Set the universe to which the fixture is connected by clicking in the “U” box and typing either 1 or 2.

- Fixtures patched to U1 (Universe 1) have their DMX output on the “Isolated DMX1” connector and can also be output on any SACN or ArtNet universe.

- Fixtures patched to U2 (Universe 2) have their DMX output on the “Isolated DMX2” connector and can also be output on any sACN or ArtNet universe.

See section 18.5 for more information on mapping U1 and U2 to sACN and ArtNet outputs.

Set the DMX address (to match the DMX address on the fixture you are patching) by clicking the **+10**, **+1**, **-10** and **-1** buttons or by clicking in the “**DMX Address**” box and typing the address number.

Click **Patch** and the fixture number selection screen opens.

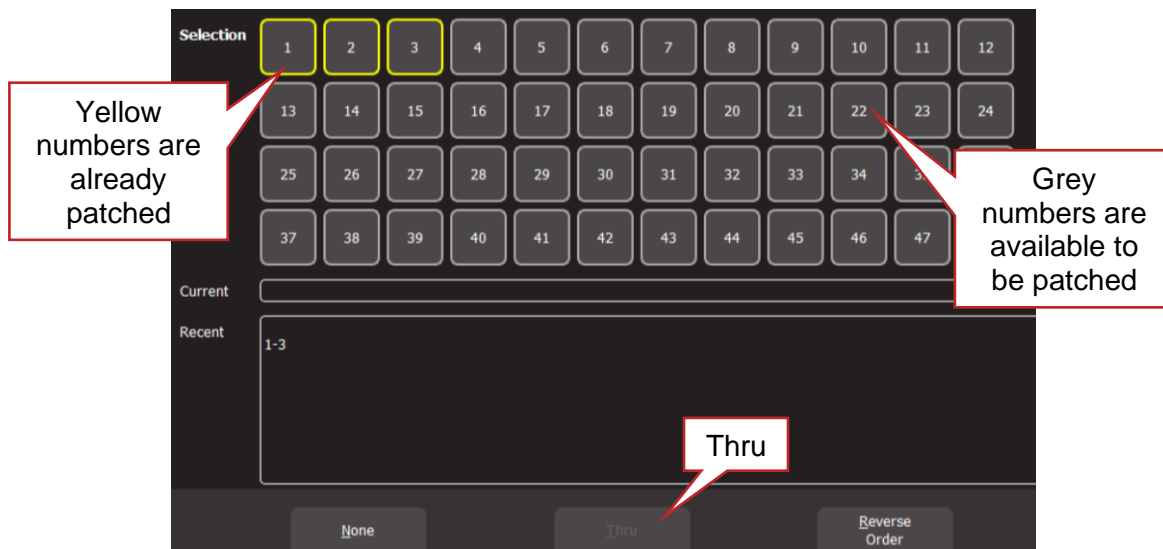

To make the patch, click a **fixture number** (1 through 96). Available fixture numbers are grey. Already patched fixture numbers have a yellow border.

When you select a fixture number, the “Intensity” wheel and buttons become active. To test the patch, you can either click **100%** or click and rotate the **Intensity wheel** and the fixture will come on with white light.

Hint: If the fixture does not come on and you are certain that you have patched it correctly (including the correct universe), check that the fixture is correctly connected via DMX cable, is switched on and is set to the correct DMX address and mode.

Click  **Back/Home** to return to the Patch screen.

Repeat the above steps for each fixture to be patched.

When finished patching double click  **Back/Home**.

Hint: Save your show. See section 17.

7.3 Patching Multiple Fixtures in One Operation

If you have multiple fixtures of the same type and mode that are set to contiguous DMX addresses you can speed up the patching process and patch them all in the one operation.

Use the same procedure as described above (Patching a Fixture) to select the manufacturer and model of fixture and the DMX address of the first fixture in the range.

Select a fixture number for the **first fixture** in the range then click **Thru** then click the **last number** in the range then click  **Back/Home**. Alternatively, instead of using the “Thru” function you can individually select each fixture number. All of the selected fixtures will be patched in order. The DMX address that you set for the first fixture is automatically incremented for each fixture according to the quantity of DMX slots used by each fixture.

For example. To quickly patch 6 identical RGB LED fixtures that each use 3 DMX slots, set the fixtures to contiguous DMX addresses of 1, 4, 7, 10, 13 and 16 respectively. In the Patch screen set the DMX address to 1 (the first fixture’s address). To patch all 6 fixtures, click **Patch**, **1**, **Thru**, **6**,  **Back/Home**.

7.4 Multi-Patch. Patching Multiple Fixtures to the Fixture Number

Multiple fixtures of the same type and mode but with different DMX addresses can be patched to the same fixture number. This frees up fixture numbers for other fixtures. Multi-patching is often done when multiple fixtures have a common purpose (such as a colour wash on the stage or all of the house lights) and you want to control them all from the same fixture number.

Note: You could set each fixture to the same DMX address and only make one patch to achieve the same result but sometimes you might not be able to access the fixtures to change their addresses or do not have permission to change their addresses so you need to use their existing addresses.

Remember that each actual fixture must be the same type and be set to the same mode of operation.

To Multi-Patch, from the “Home” screen, click **Tools, Setup, Patch**.

Use the same procedure as described in section 7.2 to select the type and model of the fixture then set the Universe (U) and DMX address to match the address of the first fixture to be patched.

Click **Patch** then select a **fixture number**. The number that you choose will be used to control all of the fixtures that you will patch to it. If you either click **100%** or click and rotate the **Intensity wheel**, the fixture will come on with white light.

Click  **Back/Home** to return to the Patch screen.

Set the DMX address (top right-hand corner of the patch screen) to match the DMX address of the second fixture to be patched.

Note: After you made the first patch, the DMX address automatically advanced to the next available DMX address, ready for another fixture to be patched. This might not be the address of your next fixture. Check and set the DMX address on the patch screen to match the DMX address of your next fixture.

Click **Patch** then click on the same fixture number. The second fixture will also come on. You now have two fixtures with different DMX addresses both being controlled by the fixture number.

Continue patching as many fixtures as required of the same type/mode/settings to the same fixture number by setting the DMX address on the patch screen to match each fixture and clicking **Patch** and selecting the same fixture number.

When finished patching double click  **Back/Home**.
To un-patch a fixture from a multi-patch see section 7.8

7.5 Patching Compound Fixtures

A “compound” fixture is a fixture that contains multiple fixtures within the one fixture. Compound fixtures are also known as “Multi-Cell” fixtures.

For example, many RGB (Red, Green, Blue) LED strips are compound fixtures because they have multiple RGB cells within the one fixture. The fixture usually has a screen that allows you to select different “modes” of operation. A simple mode might provide 3 control channels (RGB) that control the entire fixture. Other modes might allow you to divide the fixture into 3 sections and use 9 channels to control the RGB of each section. The most complex mode might allow you to individually control every pixel.

Complex modes use a lot of DMX channels and can be difficult to program. Compound fixtures usually also have modes that allow you to control effects that are built into the fixture such as pixel mapping effects, colour pulsing or chase effects. These modes use some of the DMX channels to control those effects and this makes the fixtures much easier to program.

LSC recommends that when patching compound fixtures, you select a mode that uses the least quantity of channels but includes channels that control the built-in effects.

For example, a Chauvet DJ COLORband © LED strip fixture has multiple modes available:

- 3 channel mode has RGB channels for the whole fixture.
- 7 channel mode has RGB channels for the whole fixture plus channels for colour effects, speed, strobe, pulse/snap/fade and intensity.
- 12 channel mode splits the fixture into 4 sub-fixtures with RGB for each sub-fixture.
- 24 channel mode splits the fixture into 8 sub-fixtures with RGB for each sub-fixture.

In this case LSC recommends patching the fixture in 7 channel mode and utilising the in-built effects of the fixture. This will allow you to create complex effects in a fraction of the time than when operating in the other modes.

7.6 View Patch

If you want to see and check all of the patches you have made from the Patch screen, click **View Patch**.

If you click a fixture in the “Current Patch Information” pane on the left side of the screen, the details of the channels for that fixture are shown in the “Fixture” pane on the right side.

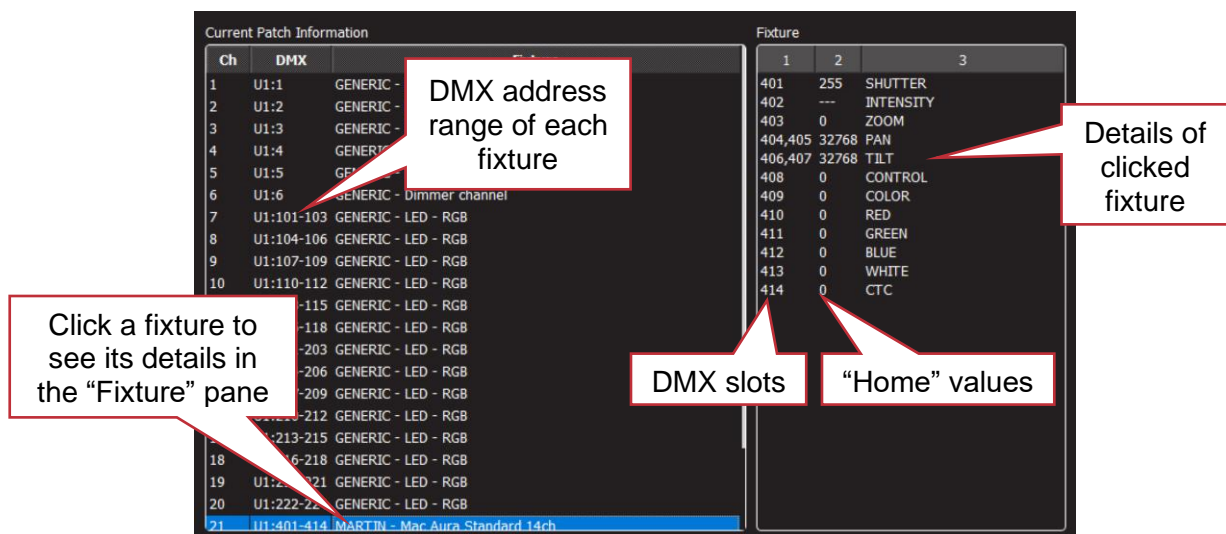

View Patch

For a description of “Home” values see section 7.10. To return to the Patch screen, click **Back/Home**.

7.7 Un-Patching a Fixture(s)

From the “Home” screen click **Tools, Setup, Patch, Unpatch**.

Click a fixture number button to unpatch it. Multiple fixture numbers can be selected.

When finished, click  **Back/Home**.

7.8 Un-patch a Multi-Patched Fixture

Multiple fixtures of the same type and mode but with different DMX addresses can be patched to the same fixture number as described above. You can un-patch individual fixtures from a multi-patch or un-patch all fixtures in the multi-patch.

From the “Home” screen click **Tools, Setup, Patch, Unpatch**.

Click a fixture number button to unpatch it. Multiple fixture numbers can be selected.

The screen shows with a list of fixtures patched to the selected fixture number. The centre of the screen shows a list of the fixtures in the multi-patch with their Universe and DMX address range.



Click the **Select** buttons of the fixture(s) that you wish to remove from the multi-patch.

You can also use **Select All** or **Unselect All**.

Click **Apply** and the selected fixtures will be unpatched.

Note: Multiple fixture numbers can be selected when un-patching. If multiple fixture numbers are selected and some are multi-patched you will be shown the following warning when you click **Unpatch**:

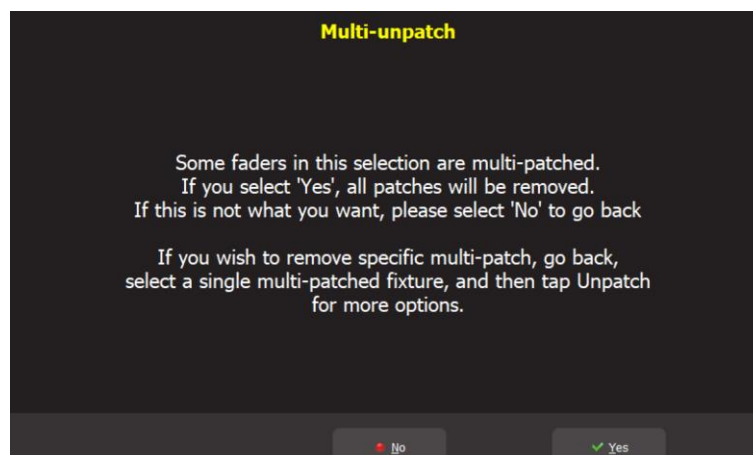

Click **No** then select a single multi-patched fixture number and follow the instructions above.

7.9 Save Patch

When you save a show, the patch is saved as part of that show. See section 17.

7.10 Home Values

When you “Clear” a fixture (see section 6.4), if the fixture has a colour mixing function (RGB or CMY) Mantra Mini will set its colour to white and if it has a movement function it will centre the pan and tilt. These values are hard coded in the Mantra Mini. All other attributes of the fixture will be set to their “home” values that are listed in their fixture template. You can see these values in the “View Patch” screen (above). Typically, these values will set a colour wheel to clear, gobo wheel to open, shutter to open etcetera so that the fixture outputs an open white beam.

7.11 Fixture Editor

If you have a new fixture and it is not listed in the Mantra Mini fixture library you can create a template for it. You can also use the Fixture editor to edit an existing fixture template. See section 19 for details.

8 Rig View

8.1 Overview

The fixture icons on the “Home” screen of the Mantra Editor can be arranged geographically so that they are positioned on the screen in a similar fashion to their position in your installation. This can assist you in quickly identifying fixtures.

8.2 Arranging Icons

To arrange the icons, click and HOLD any of the fixture icons for 2 seconds. A yellow flashing dotted box appears around the icons. Whilst the yellow box is flashing you can drag and drop individual fixture icons to position them on screen. You can also change the size of the icons or reset to the default positions.

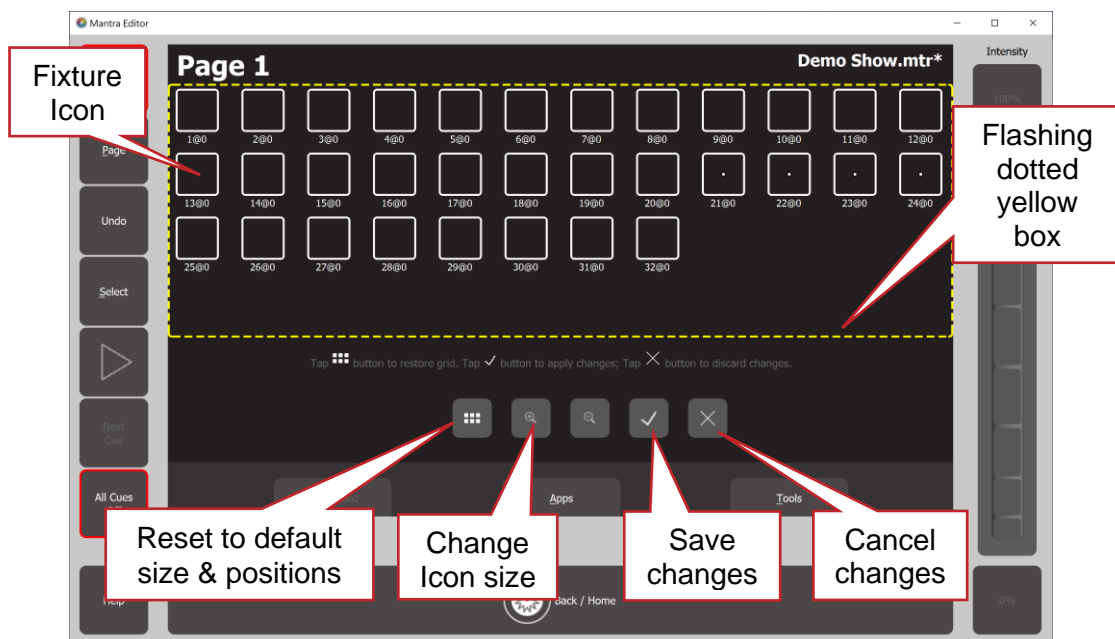

Click to save your layout and exit.

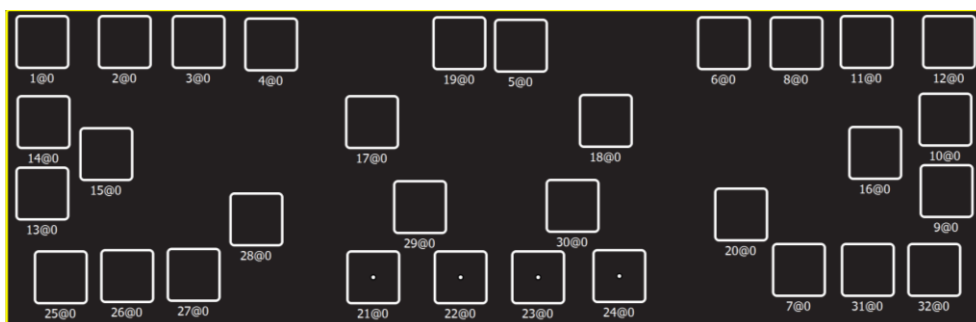

Example of Icons re-positioned to match actual rig positions

9 Controlling Fixtures

9.1 Selecting Fixtures

To control the intensity, colour, position or beam attributes of a fixture(s) you need to select the fixture(s). There are several methods of selecting fixtures.

1. On the Home screen, clicking a fixture icon selects that fixture (its number background turns yellow).

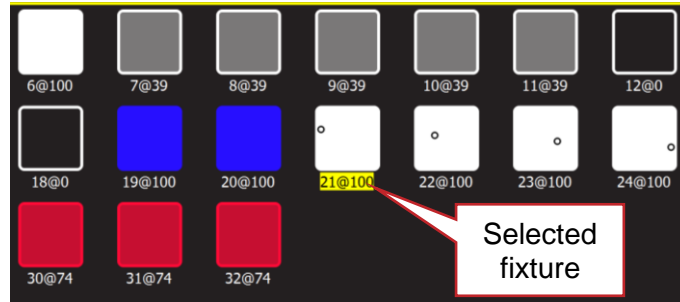

Multiple fixtures can be selected. Click a selected fixture again to de-select it.

2. Click **Select**.

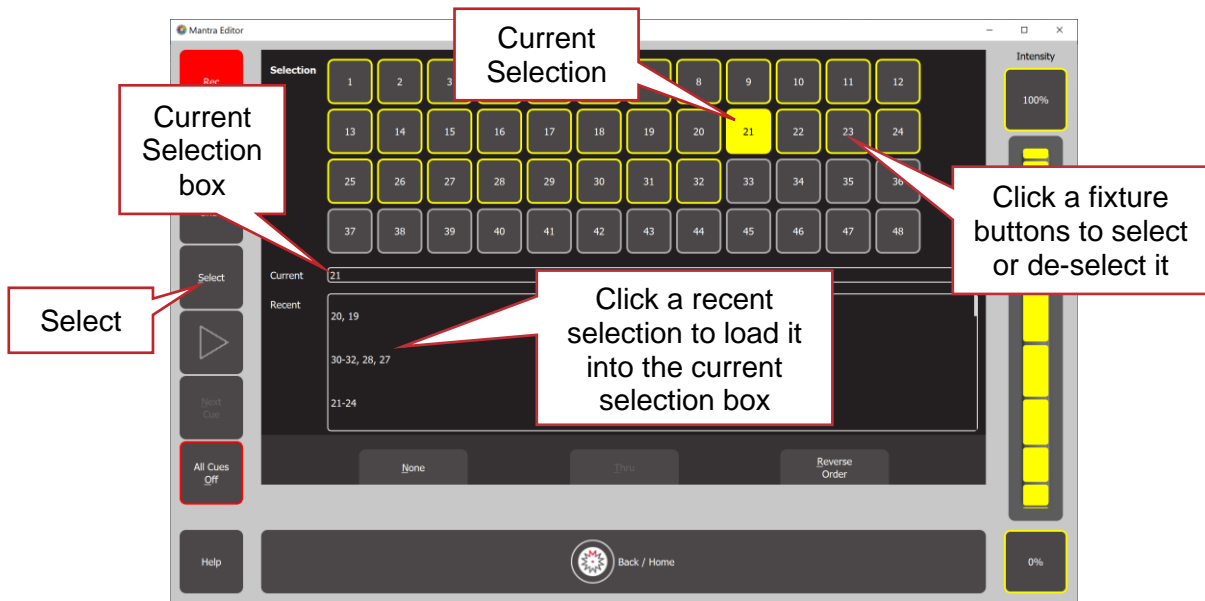

Select Screen

The “Selection” area (the top half of the screen) shows all the fixture numbers.

- Patched fixture numbers have a yellow border
- Un-patched fixture numbers have a grey border
- Selected fixtures have a yellow background

Click a fixture to select or de-select it. Multiple fixtures can be selected. To select a range of fixtures, click the first fixture in the range then click **Thru** then click the last fixture in the range.

The “Current” area (in the middle of the screen) shows the current selection, in the order in which they were selected.

The “Recent” area (the bottom half of the screen) shows a list of recent selections. Scroll down to see more (if available). Click a recent selection to load it into the current box.

To reverse the current selection order, click **Reverse Order**.

To clear the current selection, click **None**.

Click  **Back/Home** when finished selecting.

***Hint:** When you select multiple fixtures, the order in which you select the fixtures is used by Mantra Mini when you fan colours or positions and in animations and shapes. You can change the look of a fan, animation or shape by changing the selection order.*

***Note:** When using Apps to control fixtures, you can only select fixtures that have attributes that can be controlled by that App. For example, if you use the colour App you cannot select a dimmer because it does not have a colour attribute.*

9.1.1 Automatic Fixture De-select

After you changed the intensity or have used an App to change any attribute of the selected fixtures, selecting another fixture will cancel the previous selection and start a new selection process. This speeds up operations because you don't have to de-select fixtures once you have set their attributes.

For example: Open the Colour Picker App and select fixtures 1 and 2. Pick a colour. Select fixtures 3 and 4. This de-selects 1 and 2 and selects 3 and 4. Pick a colour for 3 and 4.

9.2 Fixture Intensity

To adjust the intensity, select the fixture(s) then either,

- Click and drag the "Intensity" wheel
- Hover your mouse above the intensity wheel and scroll the mouse wheel
- Click the 100% or 0% buttons
- Press the computers' ↑ (up) key to increase intensity by 1%
- Press the computers' ↓ (down) key to decrease intensity by 1%
- Press the computers' PgUp (page up) key to increase intensity by 10%
- Press the computers' PgDn (page down) key to decrease intensity by 10%

9.3 Fixture Attribute Apps

Mantra Editor uses "Apps" on to control the attributes (colour, pan/tilt, shutter etcetera) of the selected fixtures. From the "Home" screen clicking **Apps** (or keyboard shortcut **A**) opens the "Apps" screen.

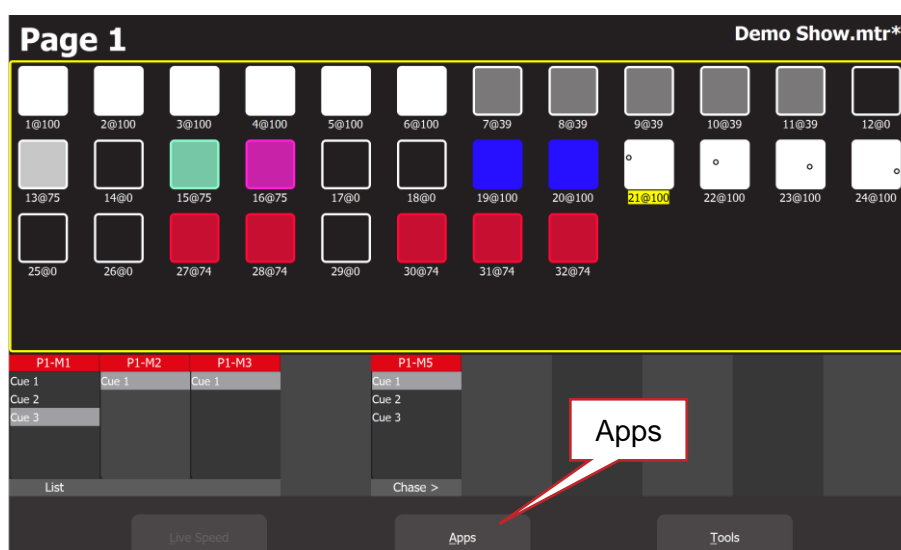

"Home" Screen

The Apps screen opens:

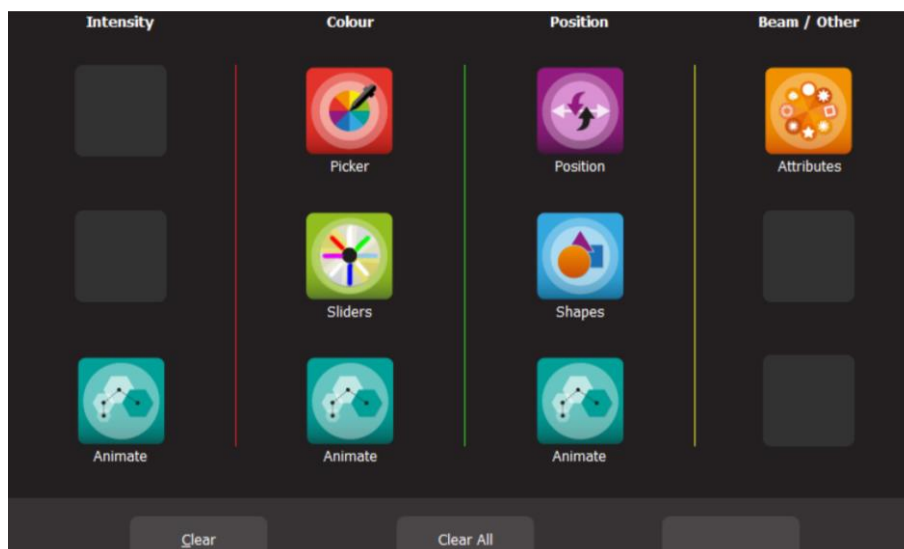

Apps Screen

Click the App icon for the type of attribute that you want to control then select the fixture(s) to be controlled. Apps are arranged in 4 attribute columns. Each column has Apps for their type of attribute.

Intensity Column.

The Intensity “Animate” app allows you to create intensity classes and patterns.

Colour Column.

The “Picker” apps allow you to control the colour of selected fixtures and to “fan” colours across multiple fixtures. The “Sliders” app provides individual sliders for all colours for selected fixtures. The “Animate” app allows you to create colour classes and patterns.

Position Column.

The “Position” app allows you to control the pan and tilt position of selected fixtures and to “fan” positions across multiple fixtures. The “Shapes” app provides a quick and simple way of creating continuously moving positions. The “Animate” app allows you to create moving beam effects.

Beam / Other Column.

The “Attributes” app allows you to control all beam attributes such as “Gobo”, “Colour Wheel”, “Shutter” etcetera plus any other attributes of the selected fixture.

- All Animate Apps are described in section 10.
- The Shapes App is described in section 11.

9.4 Controlling Colour

9.4.1 Picker App

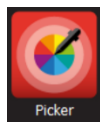

From the “Home” screen, open the “Apps” screen (described above) then click the colour Picker app icon. Select the fixtures (described above) then click (and drag) to change the colour. Only fixtures that have colour attributes can be selected. The final colour is selected when you release the mouse button. The side of the colour picker app shows the recently selected colours (latest at the top). Click any of the recent colours to re-use them.

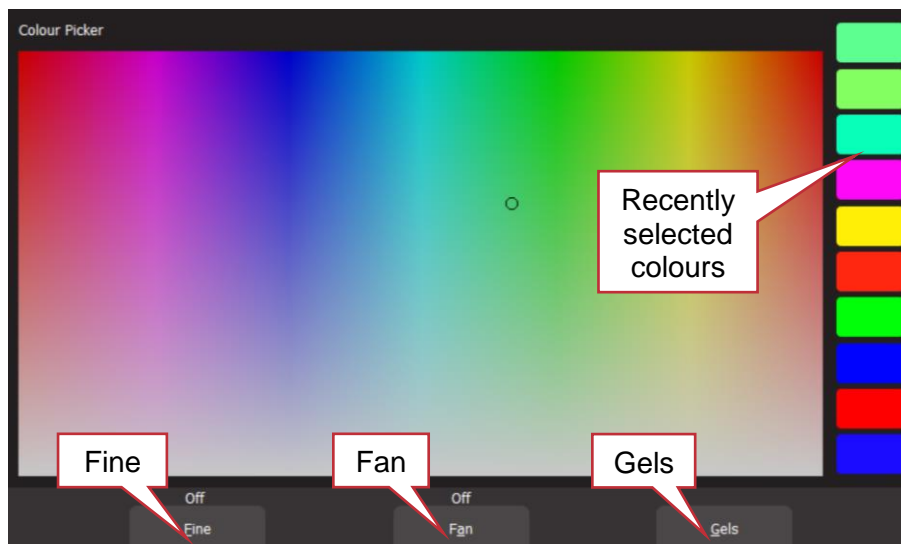

Colour Picker

9.4.2 Fine

Clicking Fine provides finer control of colour. Click again for normal control.

9.4.3 Fan

When multiple fixtures are selected you can fan their colours to create rainbow effects.

- Clicking Fan selects “Directional” fanning. Click to set the first colour then click and drag to fan the colours across the selected fixtures. The first fixture in your selection has the colour where you first clicked and the last fixture in your selection has the colour where you stopped dragging.
- Clicking Fan again selects “Symmetrical” fanning. Click to set the first colour then click and drag to fan the colours across the selected fixtures. The first and last fixtures in your selection have the colour where you first clicked and your finish colour, where you stopped dragging, is in the centre of you fixture selection.
- Clicking Fan again turns fanning off.

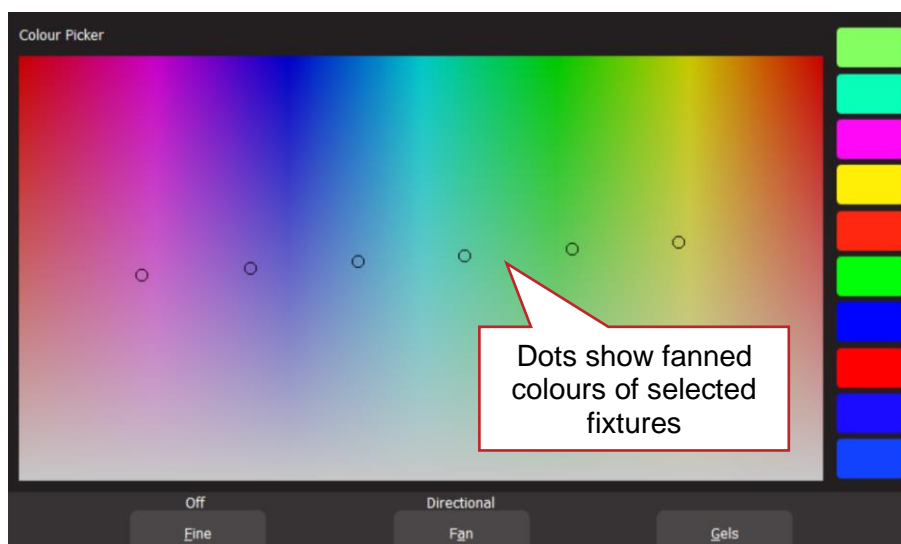

Directional Fanning

Your fixture selection order is used by the Fan App. Experiment with different orders of selection to get different colour effects. Previous selections can be re-used by clicking the **Select** button.

9.4.1 Gels App

Clicking **Gels** provides commonly used colour gels.

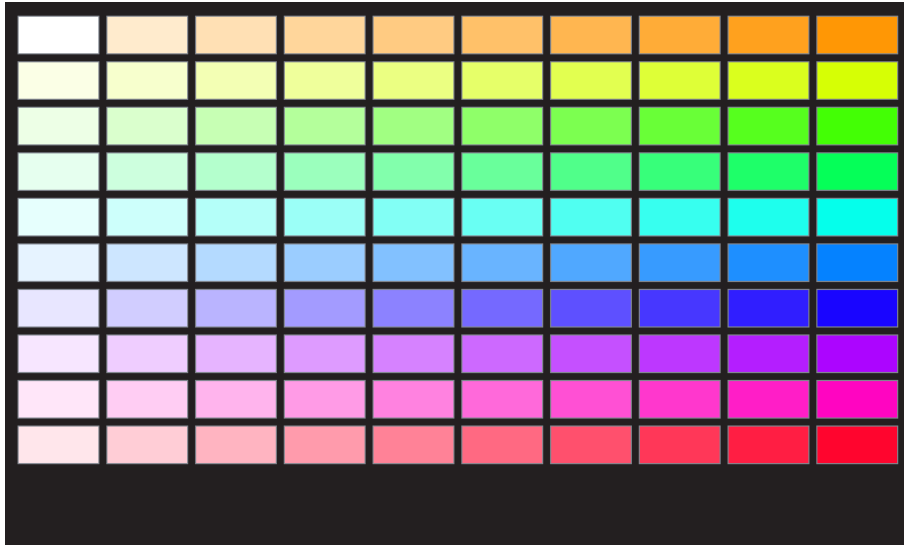

Colour Gels

Click a colour to apply it to your selected fixtures.

9.4.2 Sliders App

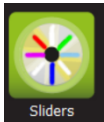

From the “Home” screen, open the “Apps” screen (described above) then click the colour Sliders app icon. Select the fixtures (described above) then use the individual colour sliders to control the selected fixture. Only fixtures that have colour attributes can be selected.). Up to 5 attributes are displayed on a page. Click **Next** to see more attributes (if available).

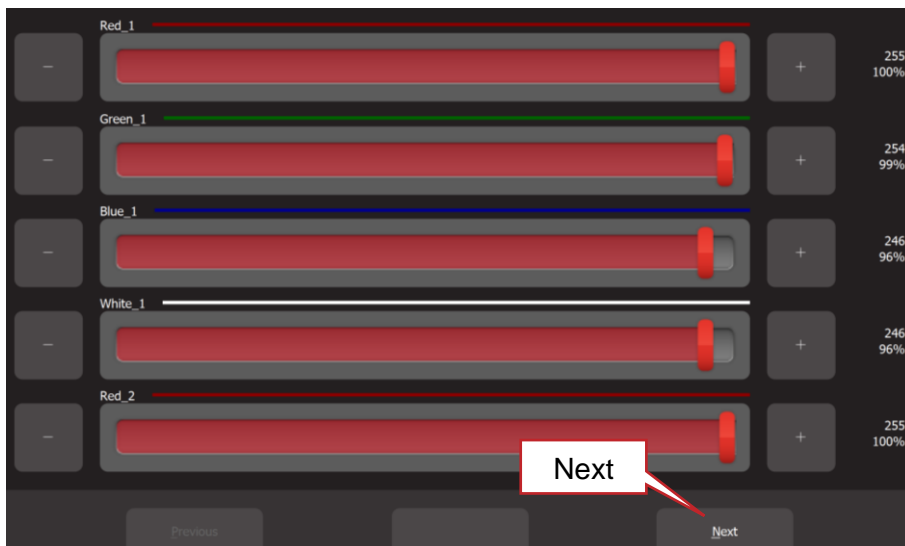

Colour Sliders

- + and – buttons are provided for small increments.
- The hexadecimal and percentage values of each slider are shown on the right.

9.5 Controlling Position

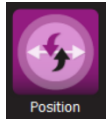

From the “Home” screen, open the “Apps” screen (described above) then click the “Position” app. Only fixtures that have Position (pan and tilt) attributes can be selected. Select the fixtures (described above) then click and drag to move the position. You don’t have to click the current position icon to move a fixture, you can click and drag anywhere on the screen and the selected fixture(s) will follow your movements. You don’t have to click on the fixture’s dot.

You can also make fixtures move continuously in a shape or pattern. See section 11.

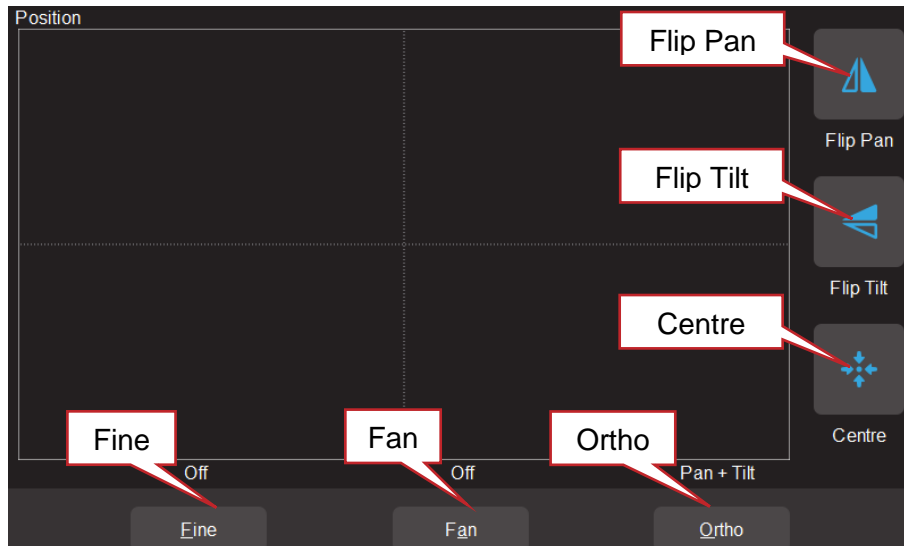

Pan /Tilt Position

9.5.1 Flip Pan/Flip Tilt

Clicking **Flip Pan** inverts the pan as you drag.

Clicking **Flip Tilt** inverts the tilt as you drag.

A blue border on the icon indicates “Flipped”. These settings are useful if the fixture movement is opposite to the movement on the screen.

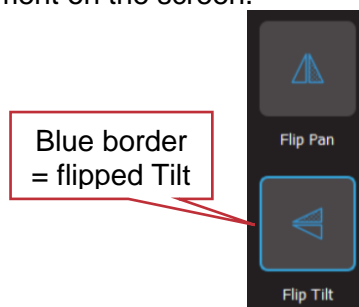

9.5.2 Centre

Clicking **Centre** moves the selected fixtures to their centre position.

9.5.3 Fine Control

For finer control click the **Fine** button. Click again for normal control.

9.5.4 Ortho Control

Clicking **Ortho** cycles through, “Pan Only”, “Tilt Only” and “Pan + Tilt”. These settings are useful when making fine adjustments.

9.5.5 Fan

When multiple fixtures are selected you can fan their positions to achieve symmetrical patterns.

- Clicking Fan selects “Centred” fanning. Click and drag to fan the positions around the centre fixture.
- Clicking Fan again selects “Directional” fanning. Click and drag to fan the positions around the first fixture in your selection.
- Clicking Fan again selects “V-Shape” fanning. This pan works best when fixtures are already fanned into a line. Click and drag to pull the line of fixtures into a V shape.
- Clicking Fan again turns fanning off.

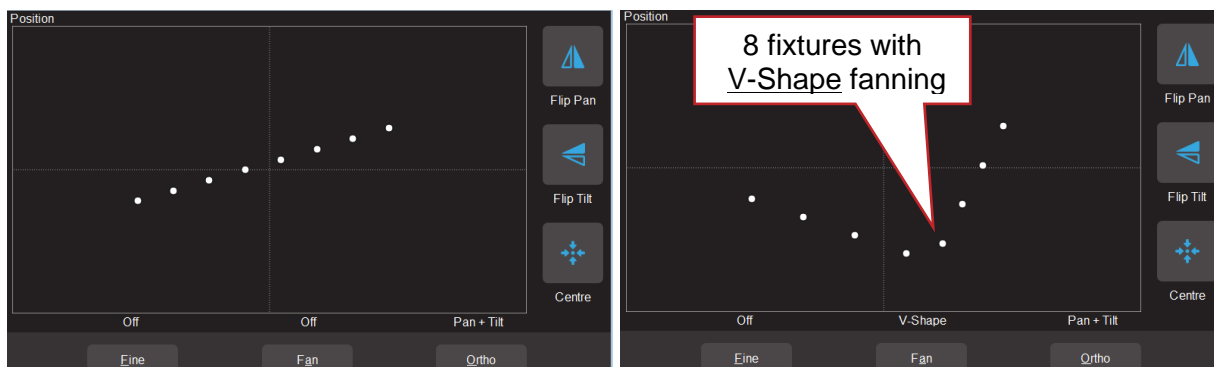

Your fixture selection order is used by the Fan App. Experiment with different orders of selection to get different shapes. Previous selections can be re-used by clicking **Select**.

9.6 Controlling Beam and Other Attributes



This app provides slider controls for all attributes not controlled by the Intensity, Colour or Position Apps. From the “Home” screen, open the “Apps” screen (described above) then click the “Attributes” app then select the fixture(s) to be controlled. Only fixtures that have Beam or other attributes can be selected. The controls will vary depending upon the selected fixture. Typical attributes are colour wheels, gobo wheels, shutter and prisms. Up to 5 attributes are displayed on a screen. Click **Next** to see more attributes (if available).

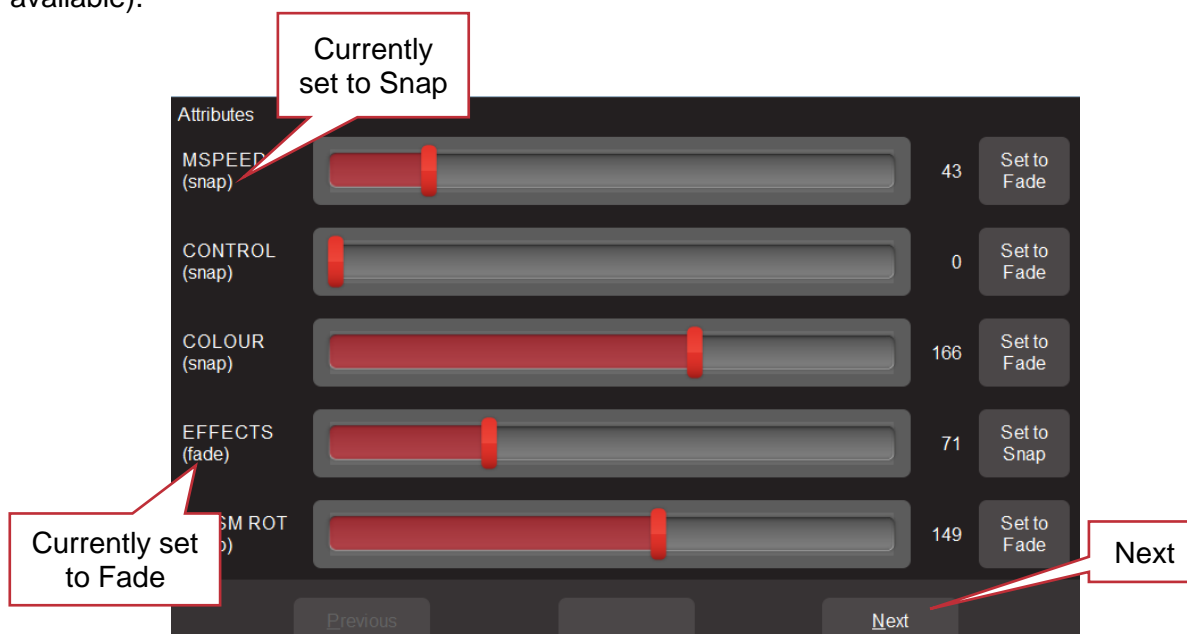

Typical “Other Attribute App”

All “Beam/Other” attributes can be set to either “Fade” or “Snap”. When you record a cue that includes the selected fixture(s), this setting will be included. When the cue is played back, attributes set to “Fade” will follow the fade times of their cue. Attributes set to “Snap” will go to their recorded value as soon as their cue starts to fade.

9.7 Clearing Fixtures

When you set the intensity of a fixture or use an App to change colour, position or beam fixture attributes, the settings for the fixtures are remembered in the Editors “Live Memory”. When you record a cue, these settings are retained in the Live Memory allowing you to make further changes and record more cues.

When you use an App to create an animation or shape it is also remembered in the “Live Memory”. However, when you record a cue, any animation or shape in the Live Memory is automatically cleared.

Whenever you are starting to program a new lighting look, it is standard practice to clear the “Live Memory” settings (see “Clear All” below) and therefore restore fixture(s) to their default settings (no intensity, open, white, centred beam) as well as delete any animations or shapes. You can also choose to only clear selected fixtures or selected attributes and retain some live settings as described below.

9.7.1 Clear All

To clear all settings (no intensity, open, white, centred beam) from the Live Memory, from the “Home” screen click **Apps**, then from the Apps screen click **Clear All**.

*Hint: It is a good idea to click **Clear All** and **All Cues Off** whenever you have any unexplained output from the Mantra Mini.*

9.7.2 Selective Clear



Apps Screen

To only clear selected settings from the Live Memory, from the “Home” screen click **Apps**, then from the Apps screen click **Clear**. The “Clear Live Memory” screen appears:

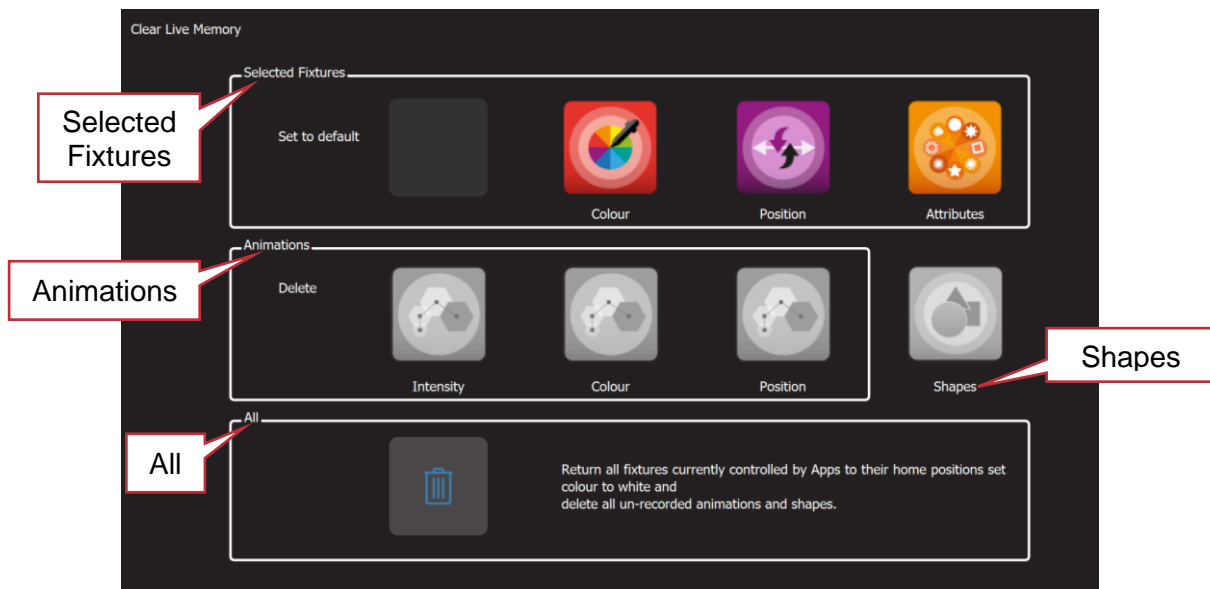

Clear Live Memory

The screen is divided into 4 sections:

Selected Fixtures can be set to their “Default” values of White, Centre and all other attributes to their “Home” values. To clear a fixture(s), select the fixture(s) (see section 9.1) then click the required Icon (**Colour**, **Position** or **Attributes**).

Animations can be selectively deleted by clicking the required Icon, **Intensity**, **Colour** or **Position**.

Shapes can be deleted by clicking the **Shapes** Icon

All. Clicking the  (**trash can**) icon will set all fixtures to their default values (listed above) whether they are selected or not. It will also delete all animations and shapes running in the “Live Memory”. Intensity in the “Live Memory” and any recorded cues are not affected.

10 Animate Apps

10.1 Overview

Animate Apps take the static output of Mantra Mini and bring it to life by providing a simple and intuitive way of creating moving patterns and colour or intensity chases.

Animations work with 2 or more selected fixtures and they shift the attribute values (such as intensity or colour or position) from one fixture to the next and loop the values of the last selected fixture back to the first. The shifting runs continuously forming a pattern or chase. There must be at least one different value amongst all of the selected fixtures (such as a different colour) so that you can see the different value being shifted from one fixture to the next.

There are Animate Apps for:

- Intensity.
- Colour.
- Pan/Tilt.

Multiple animations can be recorded in a single cue.

10.2 Creating an Animation

The basic steps to creating an animation are:

1. Program the output of Mantra Mini for the static look of the animation. Remember that there must be at least one different attribute value amongst all of the fixtures. For example, in a 4-fixture colour animation, 3 fixtures might be red and one blue or in a 3-fixture intensity chase one fixture might have intensity and the other 2 are faded down.
2. Open an Animation App (Intensity, Colour or Pan/Tilt), select all of the fixtures for the animation then click **Create** and the animation runs.
3. You can adjust the animation controls if necessary to set the speed, crossfade etcetera. See section 10.3.
4. To keep the animation for later playback, record it as a cue. See section 12.

Examples of intensity, colour and pan/tilt animations are described in section 10.4

Multiple animations can be running simultaneously and all the animations that are running when a cue is recorded will be included in the cue.

***Hint:** The order in which you select the fixtures is used by the animation app. You can get different animation patterns by experimenting with different selection orders. The selection order is shown in the animation app when you “create” the animation (see “Animation Controls” below). If you have created an animation and you want to change the selection order, click **Delete**, select the new fixture order then click **Create**.*

***Note:** If you create an animation then decide to Record the animation into a cue, the recording process automatically clears that animation from the live memory. Therefore, if you want to see the animation again, play back the cue.*

10.3 Animation Controls

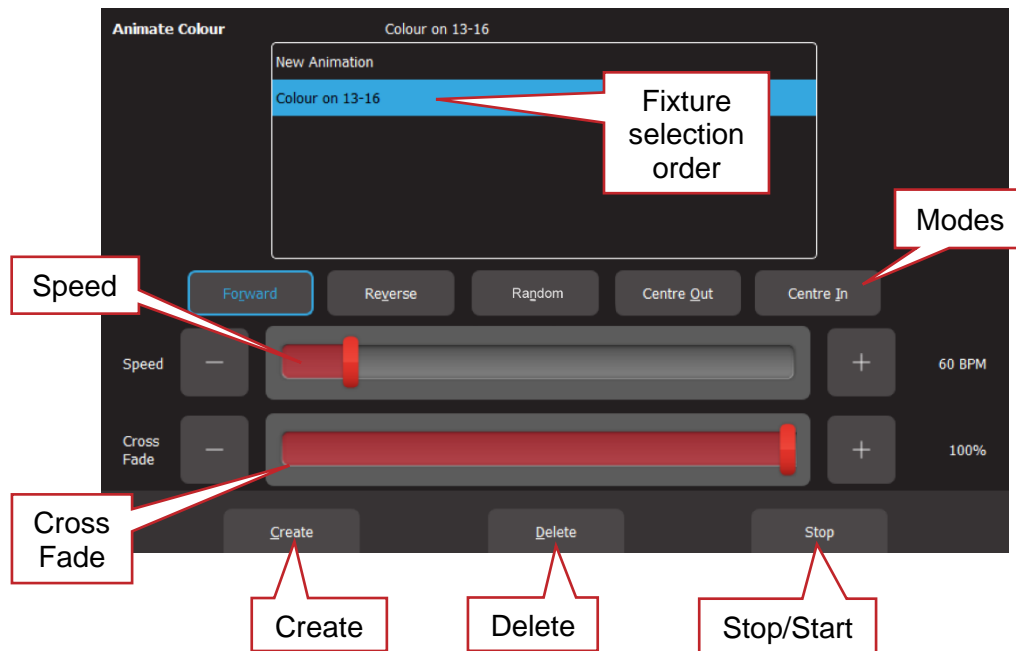

All animation Apps have Slider controls for:

- Speed in BPM (Beats Per Minute)
- Crossfade between steps (as a percentage of the speed).

For example, if the speed is set at 60 BPM (which is one step per second), then with crossfade set at 0% (that is, no fade), the animation will wait for one second, then snap to the next step. None (0%) of the available speed time will be used for crossfading.

If the crossfade is set to 50%, then the animation will perform a 0.5 second crossfade to the next step, wait for 0.5 seconds and then perform the next crossfade. That is, 50% of the time is used to perform a crossfade and 50% of the time is spent waiting before starting the next crossfade. If the crossfade is set to 100%, then the animation will use 100% of the time performing a crossfade to the next step. When the crossfade is complete, the next crossfade will commence immediately.

Animations can be run in the following modes. These choices will only be noticeable when 3 or more fixtures are in the animation.

- Forward or Reverse
- Random
- Centre Out or Centre In. These choices work best with an odd quantity of fixtures so that the pattern is symmetrical around the centre fixture. If you have an even number of fixtures there is no centre fixture because the centre is the gap between fixtures. You must therefore program a symmetrical static look with at least one different setting on both sides of centre.

You can also **Stop** and **Start** the animation.

*Note: Changing modes between Forward (or Reverse) and Centre In (or Centre Out) on a running animation can cause unexpected (and sometimes interesting) results depending upon the position of the animation pattern at the instant that you change modes. For consistent results you should **Stop** the animation, change modes then **Start** the animation again.*

10.4 Animation Examples

The following sections have examples of how to create intensity, colour and Pan/Tilt animations. All animations have the same controls available to vary the animation.

*Hint: It is a good idea to clear all fixtures before you start to create your first animation. From the "Home" screen click **Apps, Clear All**.*

If you already have an animation running that you want to retain, then only clear the type of attribute in the new animation. For example, if you have a colour animation running and you want to create a Pan/Tilt animation. From the "Home" screen click **Apps, Clear, "Animations", Position**.

10.4.1 Intensity Animation

Example 1:

To create a four fixture intensity animation with only one fixture on at a time (a chase) using fixtures 1 to 4:

- Click **Apps**,
- Select fixture 1 and fade up its intensity
- Click **Back/Home**
- Open the "Intensity" **Animate** app
- Select fixtures 1 thru 4
- Click **Create** and the animation runs as an intensity chase on fixtures 1 to 4
- Use the controls described above to set the rate, crossfade, direction etcetera

	Fixture 1	Fixture 2	Fixture 3	Fixture 4
Step 1				
Step 2				
Step 3				
Step 4				
Step 1				

Example 2:

To create a 6 fixture intensity animation with 5 fixtures on at a time using fixtures 1 to 6:

- Click **Apps, Clear All**
- Select fixtures 1, thru 5 and fade up their intensity
- Click **Back/Home**
- Open the "Intensity" Animate app
- Select fixtures 1 thru 6
- Click Create and the animation runs as an intensity chase on fixtures 1 to 6
- Use the controls described above to set the rate, crossfade, direction etcetera.

	Fixture 1	Fixture 2	Fixture 3	Fixture 4	Fixture 5	Fixture 6
Step 1						
Step 2						
Step 3						
Step 4						
Step 5						
Step 6						
Step 1						

10.4.2 Colour Animations

Example 1:

To create a red/blue colour animation across fixtures 7 to 10:

- Click **Apps, Clear All**
- Select fixtures 7, 8 and 9 and fade up their intensity then use the “Colour” Picker App to set the fixtures to red
- Select fixture 10 and fade up its intensity then use the “Colour Picker” App to set the fixture to blue

You have now created the static look of the animation.

- Open the “Colour” **Animate** App
- Select fixtures 7 through 10
- Click **Create** and the colour animation runs

Use the controls described above to set the rate, crossfade, direction etcetera.

	Fixture 7	Fixture 8	Fixture 9	Fixture 10
Step 1	Red	Red	Red	Blue
Step 2	Blue	Red	Red	Red
Step 3	Red	Blue	Red	Red
Step 4	Red	Red	Blue	Red
Step 1	Red	Red	Red	Blue

Example 2:

To create a fanned colour animation across fixtures 13 to 20:

- Click **Apps, Clear All**
- Select fixtures 13 to 20 and fade up their intensity
- Open the “Colour” Picker App and select “Symmetrical Fan” by clicking Fan twice then drag to fan the colours across the selected fixtures

You have now created the static look of the animation.

Hint: Choosing “Symmetrical”, fans the colours around the centre fixture(s) so that the first and last fixtures have similar colours. This gives the animation a smooth colour transition from last fixture to the first fixture.



- Open the “Colour” **Animate** App
- Select fixtures 13 through 20
- Click **Create** and the fanned colours animate through the selected fixtures
- Use the controls described above to set the rate, crossfade, direction etcetera

10.4.3 Pan/Tilt Animations

Example 1:

To create a Pan/Tilt animation across fixtures 21 to 24:

- Click **Apps, Clear All**
- Select fixture 21 thru 24 and fade up their intensity
- Open the “Pan/Tilt” **Position** App
- Select fixture 21 then click and drag the position to the front of the stage
- Select fixtures 22, 23 and 24 then click and drag their position to the back of the stage

You have now created the static look of the animation.

- Open the “Pan/Tilt” **Animate** App
- Select fixtures 21 thru 24

- Click **Create** and the Pan/Tilt animation runs
- Use the controls described above to set the rate, crossfade, direction etcetera

Example 2:

To create a fanned Pan/Tilt animation across fixtures 21 to 24:

- Click **Apps, Clear All**
- Open the “Pan/Tilt” Position App
- Select fixtures 21, thru 24 and fade up their intensity
- Click **Fan** then click and drag to fan the fixture positions

You have now created the static look of the animation.

- Open the “Pan/Tilt” **Animate** App
- Select fixtures 21 thru 24
- Click **Create** and the Pan/Tilt animation runs
- Use the controls described above to set the rate, crossfade, direction etcetera

You can return to the **Position** app if needed and reposition the animation.

10.5 Multiple Animations

If you already have an animation(s) running you can still create another one of the same type (Intensity, Colour or Position) by clicking **New Animation**. Select the fixtures to be included then click **Create**. All of the animations of the selected type are listed in the box.

When multiple animations are running you can switch the controls to any of them by clicking their name.

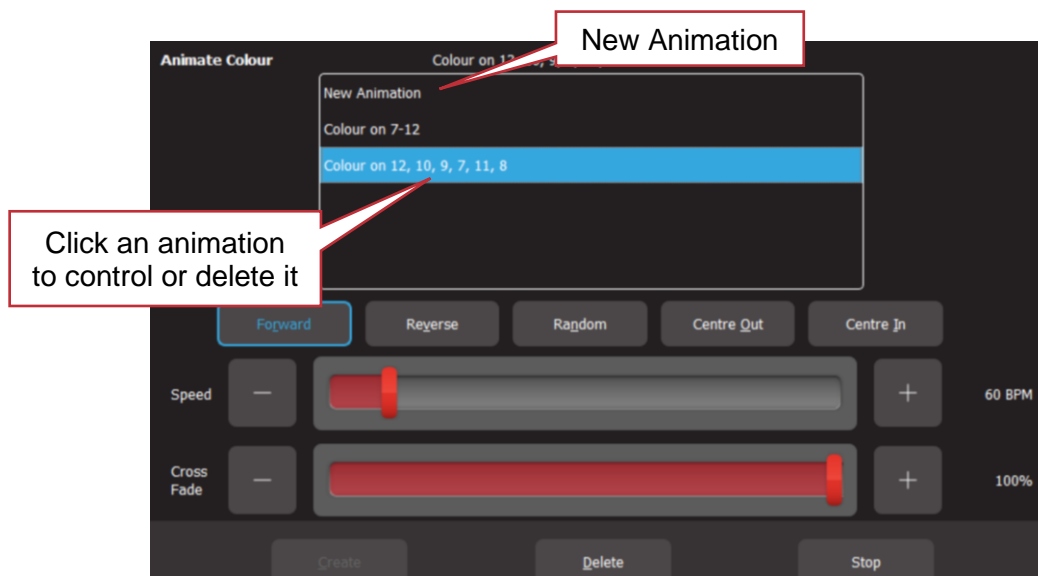

10.6 Recording Animations

When you record the output of the Mantra Mini as a cue it includes any animations that are running. Recording an animation will automatically clear that animation from the “Live Memory” where you created it. To see the animation again, playback the recorded cue.

10.7 Deleting Animations

To delete a single animation from the “Live Memory”, open the Animation app in which it is running (Intensity, Colour or Pan/Tilt), click the animation number then click **Delete**

To delete all animations of one type (Intensity, Colour or Pan/Tilt), from the “Apps” screen, click **Clear** then from the “Animations” pane choose to delete either **Intensity**, **Colour** or **Position** animations.

To delete all animations (and shapes) and restore all fixture(s) to default settings (open, white, centred beam), from the “Apps” screen, click **Clear** then **All** (trash can icon).

10.8 Animations in a Chase

A chase is cue-list that automatically steps from cue to cue. Any cue in a chase can contain animations so complex effects can be easily created by including a different animation in each step of a chase.

11 Shapes App

11.1 Overview

The Shapes App provides a quick and simple way of creating continuously moving positions on fixtures that have Pan and Tilt attributes by constantly varying those attributes.

11.2 Creating a Shape

Hint: You might find it easier to position your fixture(s) before you apply a shape movement to them, however you can still position them after applying the shape.

To create a shape, from the “Home” screen, open the “Apps” screen then click the “Position” **Shapes** icon.

Select the fixture(s) to which the shape is to be applied and fade up their intensity.

Click **Back/Home**.

You can select the following shapes:

- Ellipse (clockwise or anti-clockwise)
- Rectangle (clockwise or anti-clockwise)
- Triangle (clockwise or anti-clockwise)
- Random

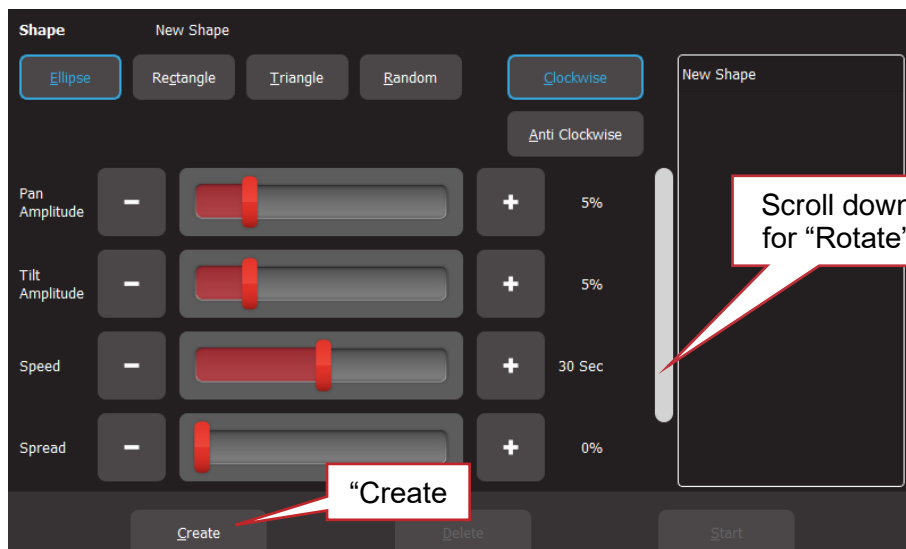

Click **Create** and the shape runs.

There are controls for:

- Pan Amplitude
- Tilt Amplitude. (Set pan and tilt to the same amplitude to create a circle when using Ellipse)
- Speed (in seconds)
- Spread (in percentage). Applies when 2 or more fixtures are selected and spreads them around the movement shape. When set to 0%, all fixtures are focused on the same point as they move around the shape. When set to 100% the fixtures are evenly spaced apart as they move around the shape. In between values vary the spread. The “Spread” control does not apply to the “Random” shape

Scroll down for:

- Rotate (in degrees). Rotates the shape about its axis. Does not apply to the “Random” shape

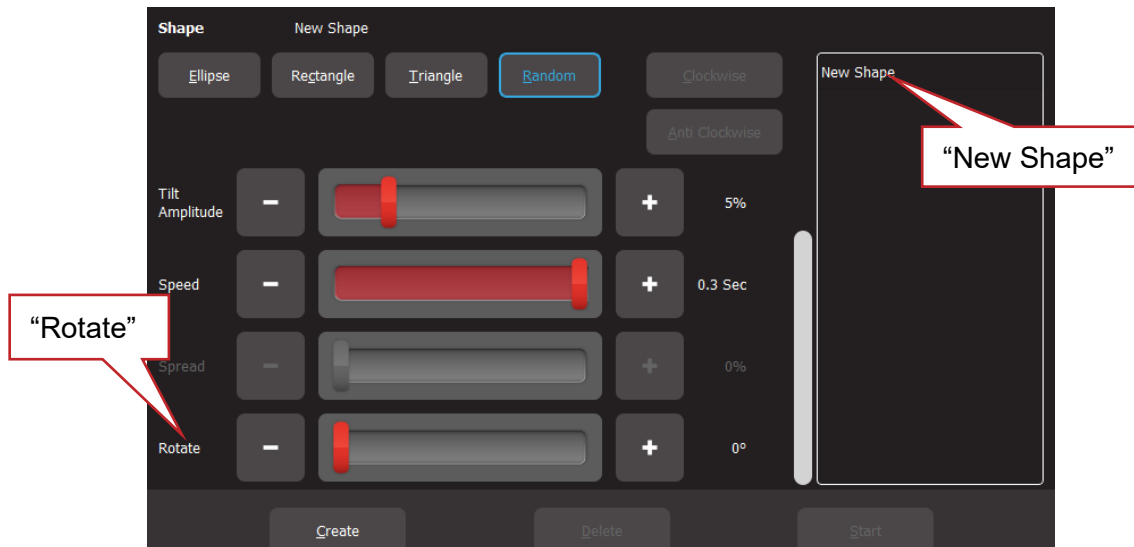

Shapes can be created on other fixtures by selecting **New Shape**, selecting the fixtures and repeating the procedure above.

11.3 Recording Shapes

When you record the output of the Mantra as a cue it includes any shapes that are running. Recording a shape will automatically clear that shape from the “Live Memory” where you created it. To see the shape, playback the recorded cue.

11.4 Deleting Shapes

To delete a single shape from the “Live Memory” open the Shapes app then click the shape (in the right-side pane) then **Delete**.

To delete all shapes (and animations) and restore all fixture(s) to default settings (open, white, centred beam), from the “Apps” screen, click **Clear** then **All** (trash can icon).

11.5 Shapes in a Chase

A chase is cue-list that automatically steps from cue to cue. Any cue in a chase can contain shapes, so complex effects can be easily created by including shapes in a chase.

12 Recording Cues

12.1 Overview

When you have adjusted the intensity and colour of your fixtures and possibly created an animation(s) or shapes, the current output can be recorded into a memory for later playback. This recording is known as a “Cue” and it contains the intensity and all other attributes such as colour, position etcetera plus any animations that are currently running. It has a “fade in” time and a “fade out” time. You can give each cue its own name (see section 14.5). If you record a cue to a Playback that already contains a single cue and choose “Add”, then you automatically create a "cue-list".

12.2 Memories / Pages

There are 10 playbacks and 10 pages of memory giving a total of 100 memories. Each memory can contain a single cue or a “Cue-list” that contains up to 250 cues. A maximum of 1000 cues can be recorded. You can give each memory its own name (see section 14.4).

- Repeated clicks of the **Page** button will step through the 10 pages of memory

The current page number is shown in the top left corner of the “Home” screen and the contents of the playbacks (for the current page) are shown along the bottom of the screen in the 10 “Playback Displayers”. The top part of each playback displayer shows the page/memory number in the form of “P#-M#” (Page number 1-10 - Memory number 1-10).

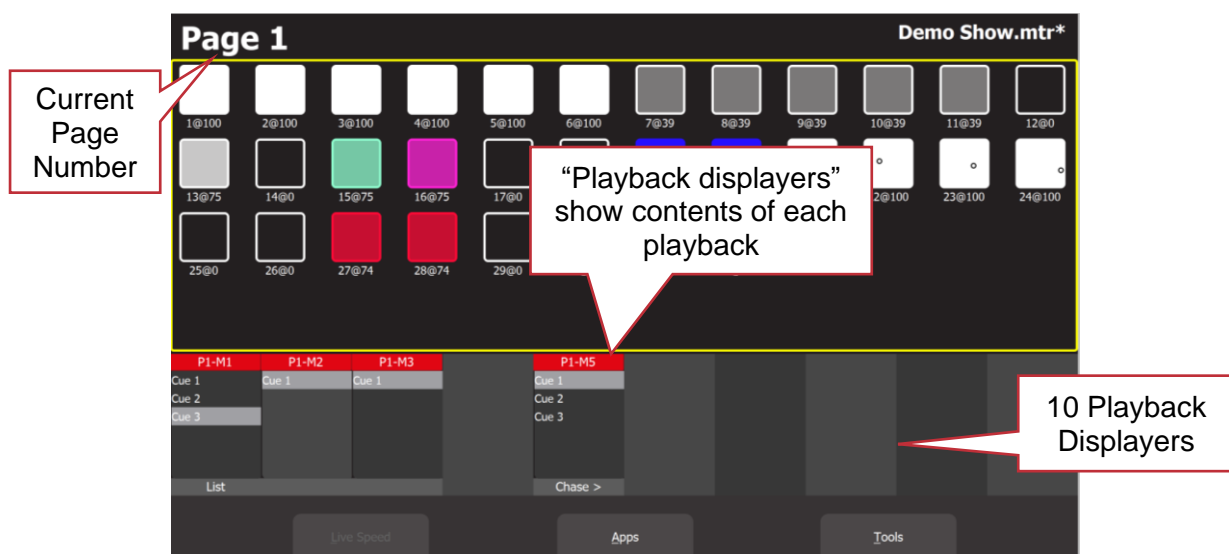

“Home” Screen

12.3 Record a Cue

To record the current output onto a Playback memory,

Click **Rec** (Record) then click the playback displayer (flashing red boxes) of your choice (**1-10**).

The recording is made into the current page. You can select a different page prior to or after clicking the “Rec” button but before selecting the playback number.

The default fade time is applied to both the “Fade In” and “Fade Out” times. To change the default fade time, see section 18.2. To set individual “Fade In” and “Fade Out” times for the cue you have recorded see section 14.2.

A new cue is automatically given the name “Cue 1”. You can change the name to suit your needs. See section 14.5.

All of the attributes of any fixture with an intensity level greater than 0% will be included in the cue. See section 12.6 for details on how to include fixtures with no intensity.

The lighting look on the output can now be played back from the recorded cue. See section 13. This allows you to create another lighting look and to record it into another cue.

12.4 Record a Cue-list (or Chase)

If you have recorded a cue into a Playback, you can record more cues to the same playback to create a cue-list. When a cue-list is played back, each time Mantra Mini receives a command to play the next cue it will perform a crossfade to the next cue in the cue-list. Each cue has its own “fade in”, “fade out” and “link (automatically plays the next cue)” time settings.

To record a cue-list, record the first cue as described in section 12. Create the next lighting look on the output then record to the same Playback number (memory location). When you select that playback number, Mantra Editor asks you to either,

- **Overwrite.** This deletes the existing cue and replaces it with your new recording. (A cue-list is not created).
- **Add.** This creates a cue-list and adds the new recording to the list.

Subsequent recordings to this memory location will automatically be added to the cue-list after the current cue without the option to overwrite.

A cue-list is usually manually advanced to the next cue but it can also be run as chase that automatically steps from cue to cue. See section 14.13. Cues can also be given a “Link Time” that will automatically play the next cue in the cue-list. See section 14.3.

Hint: It is good practice to regularly save your show.

12.5 Insert a Cue in a Cue-List (or Chase)

Create the look for the new cue on the output. When a cue is recorded to a cue-list it is added after the current cue. To select the current cue, open the “Edit Memory” screen by clicking on the playback displayer of the cue-list into which the new cue is to be inserted. Click **Next Cue** to change the current cue (blue bar).

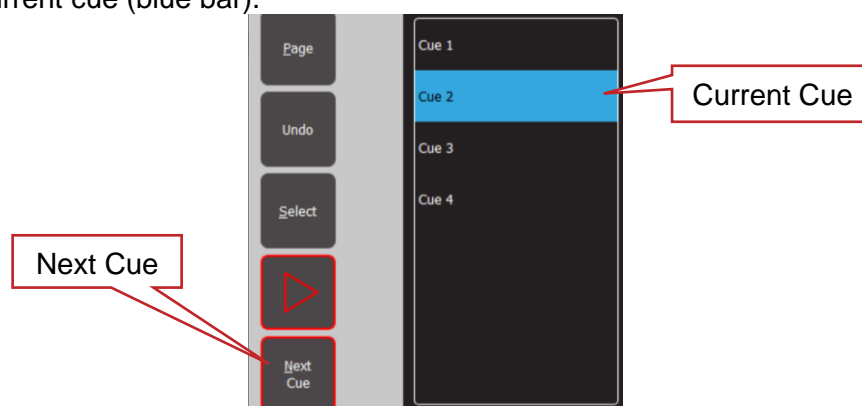

To insert the new cue, click **Rec** then click on the playback displayer of the cue-list into which the new cue is to be inserted.

If the current cue is not the last cue in the list, then the inserted cue is given the name “New Cue”.

If the current cue is the last cue in the list, then the inserted cue is given the name “Cue #” where # is the next number.

12.6 Record Fixtures with No Intensity

Normally only fixtures with an intensity level greater than 0% will be recorded in a cue however you can choose to include selected fixtures that have an intensity of 0%.

To include fixtures with no intensity, click **Rec**, then click **Select** and choose the fixtures with no intensity that you want to include in the cue. Click **Back/Home** then click a playback displayer (1-10) to make the recording.

Playing back fixtures that have no intensity can be used for a “Move in Black” or for “Solo Cues” as described below.

12.6.1 Move in Black

Playing back a cue that includes fixtures with no intensity is often used with pan and tilt fixtures to position the fixtures without seeing the move on stage. This is commonly called a “move in black”.

A move in black requires two cues:

To program the first cue, fade up the fixtures and position them on stage. Fade them down then record the cue ensuring that you include these fixtures (with no intensity) as described above.

To program the second cue that reveals the fixtures in position, fade them up and record the cue to the same cue-list.

When you playback the first cue, the fixtures move into position but are not seen as they have no intensity. When you playback the second cue (which has intensity and the same position) it reveals the fixtures already in position.

***Hint:** If the first cue of the move in black is given a “Fade In” time of 0 seconds, the fixtures will move into position as fast as possible. If the same cue is given a “Link Time” equal to the time it takes for the fixtures to reach their positions, then the second cue that fades up the fixtures will be automatically played revealing the stationary fixtures in position.*

12.6.2 Solo Cue

When you fade up a normal cue it reveals the fixtures in that cue. If you have output from other fixtures that are not in the cue they will not be affected.

If you want the cue you faded up to be the only output you usually need to fade down all other cue-lists. This can be difficult if you have multiple cue-lists active.

You can simplify this process by recording a “Solo” cue. A Solo cue has the fixture(s) that you want to see but it also includes all of the fixtures you don’t want to see. These fixtures are recorded in the cue with 0% intensity. See above 12.6.

When a solo cue is faded up it will take control (latest takes precedence) of all of the fixtures that are recorded in the cue. Therefore, any fixtures with intensities of zero will fade out.

13 Playback

13.1 Overview

There are 10 playbacks and 10 pages of memory giving a total of 100 playback memories. A memory can contain a single cue or a cue-list of up to 250 cues. (A maximum of 1000 cues can be recorded).

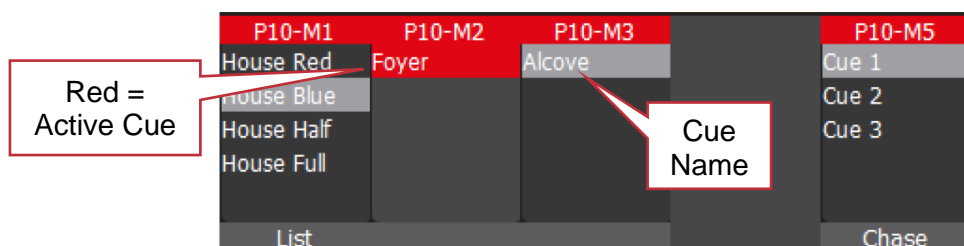

P10-M1	P10-M2	P10-M3	P10-M5
House Red	Foyer	Alcove	Cue 1
House Blue			Cue 2
House Half			Cue 3
House Full			
List			Chase

When a cue is played back it controls all of the attributes of the fixture that have been recorded in the cue. This allows you to smoothly crossfade from one Playback to another with a smooth transition of intensity, colour and position. Also see section 13.4, “Latest Takes precedence”.

13.2 Mantra Mini (Stand Alone) Playback

When the Mantra Editor is NOT connected to the Mantra Mini, playback is controlled by either the Mantra Mini’s in-built “Scheduler” (see section 15) or by “Remote Triggers” sent to the Mantra Mini from switches, or network commands (see section 16).

13.3 Editor Playback

When the Mantra Editor is controlling the Mantra Mini, cues and cue-lists can be played back under the control of the Mantra Editor. The Mantra Editor is automatically connected to the Mantra Mini whenever the Mantra Editor is used to save a show file to the Mantra Mini or loaded a show file from the Mantra Mini.

Prior to playing back a cue, it is good practice to clear any output from the “Live Memory” by clicking **Apps**, **Clear All** (keyboard shortcut **A** then **L**) and also fade down any active playbacks by clicking **All Cues Off** (keyboard shortcut **O**).

13.3.1 Playback a Cue

To playback a recorded cue using the Mantra Editor, select the page that contains the cue then click on the Playback displayer containing the cue. The “Edit Memory” screen opens.

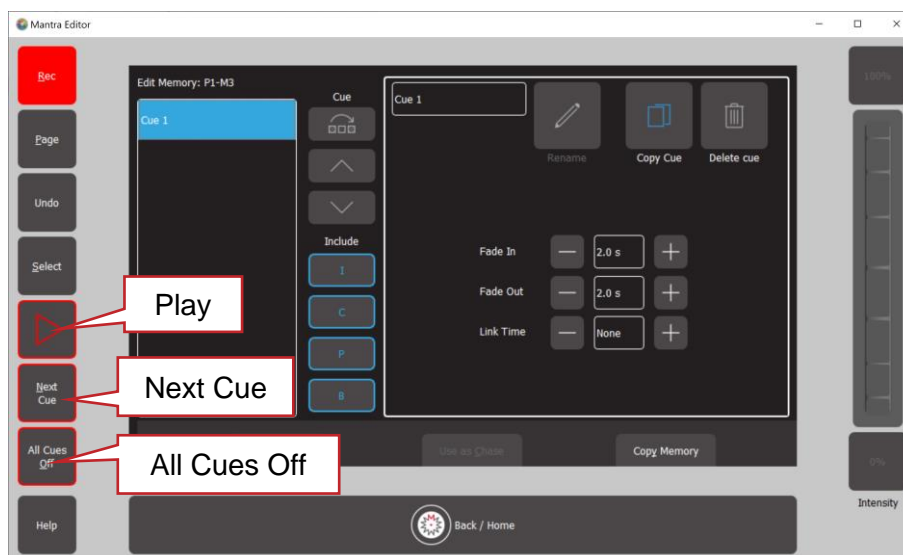

Edit Memory

To fade up the cue click ►. The ► turns red as the cue is faded up.
 To fade down the cue click ► again. The ► turns grey as the cue is faded down.

13.3.2 Playback a Cue-List

If a Playback contains a cue-list, fade up the playback (see above) then you can crossfade to the next cue in the list by clicking **Next Cue**. Cue-lists automatically loop back to the beginning after the last cue.

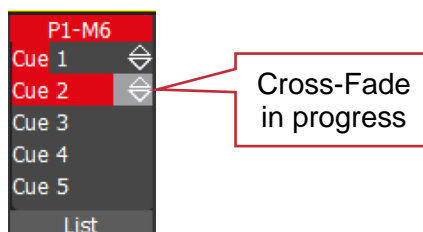

It is also possible to bypass cues and fade directly to any cue in the list. You can also rearrange the order of the cues and individually name them. See section 14.6.
 A cue-list can also be set to automatically run as a chase. See section 14.13.

13.3.3 Times

Every cue has its own “Fade In” time and “Fade Out” time. Every cue in a cue-list can also contain a “Link Time” to automatically play the next cue in the list.

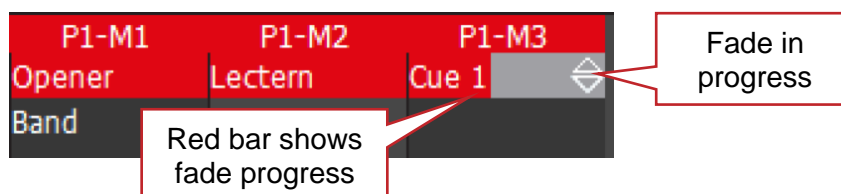

See section 14.2 for details on how to set times.

13.3.4 All Cues Off

Up to 100 playbacks can be active (faded up) at the same time. If you have multiple playbacks active across multiple pages it can be time consuming to select individually select each and fade it down.

To fade down all active playbacks click **All Cues Off**.

13.4 Latest Takes Precedence

The value for each attribute of a fixture (intensity, colour, position, etcetera) could come from multiple places within Mantra Mini. It might be from the “Live Memory” during programming or it might be from any active playback containing a cue that includes that fixture. The value for each attribute that appears on the output is determined by a method known as LTP (Latest Takes Precedence).

An LTP action occurs when a playback is played (▶). When this occurs, the playback will take control of its attributes and they will fade to their levels in that cue following the fade time. When that playback reaches 100%, it fully overrides all other active playback containing attribute values for the same fixtures. Whilst this playback remains at full no previously active playbacks have any influence over its fixture attributes. If another playback is played, it becomes the latest action and it will take control of the attributes.

The LTP rules apply to all attributes of a fixture: intensity, colour, position, etcetera.

Whilst using the Editor, when you “Select” a fixture and use the “Intensity” wheel, if the fixture already has intensity on the output from a cue on a playback, the “Intensity” wheel has no effect on the intensity of its fixture until its level matches the current level of that fixture in the cue. It then takes total (LTP) control of the fixtures’ intensity. See section 14.14.

13.5 ICPB Attributes (Filters)

When a cue is recorded it includes all of the **I**ntensity, **C**olour, **P**osition and **B**eam (I C P B) attribute groups. You can choose to exclude (filter) attribute groups when a cue is played back. This is a powerful feature. See section 14.10 for more details.

14 Edit Memory

14.1 Overview

Clicking any playback displayer opens the “Edit Memory” screen.

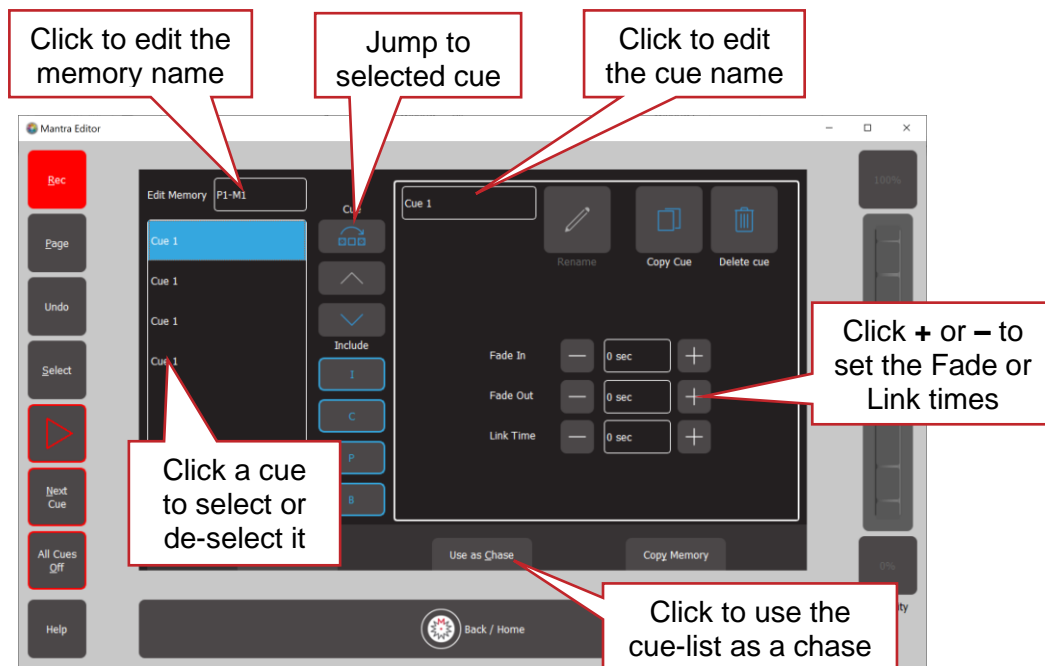
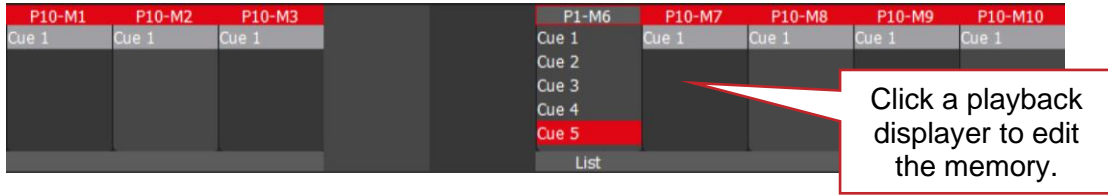

Edit Memory

The pane on the left shows the contents of the selected memory. This might be a single cue or a cue-list, depending upon what you have recorded in that memory.

If the memory contains a cue-list you can click a cue to select/de-select it. Multiple cues can be selected allowing rapid changing of all time settings as described below. If multiple cues are selected the screen shows the time settings for the last selected cue.

Clicking ► (play) will fade the cue up or down.

Clicking **Next Cue** will advance to the next cue in the list.

To edit the intensity levels or other fixture attributes in a cue see section 14.14.

To change the name of a memory, in the “Edit Memory” screen (see above), click on that memory number then delete the number and type the new the name.

When a cue(s) has been selected you can perform the following functions:

14.2 Fade Times

Every cue has a separate “Fade In” time and “Fade Out” time (0.0 seconds to 30 minutes).

When a cue is recorded it uses the default in and out fade times (2 seconds). If you usually require a different time, you can change the default fade time. See section 18.2.

When a single cue is played, the output level of that playback will fade in or fade out using the in or out fade times for that cue.

When a cue-list is played, clicking **Next cue** crossfades to the next cue in the list. The incoming cue's "Fade In" time is used and the outgoing cue's "Fade Out" time is used.

To change a Fade time, in the "Edit Memory" screen (see above), click the **+** or **-** buttons to set the "Fade In" and "Fade Out" times. If you hold a button, it will auto-repeat.

See section 13.3 for more details on fade times.

14.3 Link Time

Each cue in a cue-list can contain a "Link Time" (0.0 seconds to 30 minutes).

- If a cue in a cue-list contains a link time, then when the cue is played, the link time starts counting down. When the time expires the next cue in the cue-list is automatically played.
- If the Link Time is set to "0 sec", then the link time is ignored.

To change a Link time, in the "Edit Memory" screen (see above), click the **+** or **-** buttons to set the "Link Time". If you hold a button, it will auto-repeat.

Hint: If every cue in a cue-list has a "Link Time" value then the cue-list will run continuously in the same manner as a chase but with the difference that in a chase, the time between every step is the same whereas in a cue-list with linked cues, every cue can have a different link time. This allows you to make a chase that changes speed as it runs plus each cue can have different fade times.

14.4 Memory Name

Memory names are by default the page number and the memory number. For example, P1-M1 (Page 1, Memory 1). You can change the default name to something more descriptive. To change the name of a memory, in the "Edit Memory" screen (see above), click in the **memory name** box then type the new the name of the memory.

To restore the default name, click in the **memory name** box and delete the name then click  **Back/Home**.

Note. OSC Remote Triggers always need to be entered in the form P#-M# even if the default memory name or cue name is changed.

14.5 Cue Name



To change the name of a cue, in the "Edit Memory" screen (see above), click on that cue then in click in the **cue name** box. Type the new the name of the cue. Click **Rename** to finish.

14.6 Jump to Cue

When you click **Next Cue**, you fade to the next cue in the cue-list. If you want to bypass cues and fade directly to any cue in the list, in the "Edit Memory" screen (see above), select the cue you want to fade to and click  (Jump to cue).

Hint: This function is useful if you have a long cue-list and you want to quickly playback a cue without stepping through all of the intermediate cues.

14.7 Change Cue Order

To change the order of the cues in a cue-list, in the “Edit Memory” screen (see above), select the cue(s) to be moved then move the selected cue(s) by clicking the  (move up) or  (move down) buttons.

14.8 Copy Memory

A memory is the contents of a playback. It might be a single cue or a cue-list. To copy a memory, in the “Edit Memory” screen (see above), click **Copy Memory**. The home screen opens and all playback displays flash red. Click on a flashing red playback to make a copy. You can select a different **Page** if required, prior to clicking a playback.

14.9 Copy Cue

To copy a cue in a cue-list, select the cue in the “Edit Memory” screen (see above) then click **Copy Cue**. A copy of the selected cue is added to the end of the cue-list.

14.10 Include ICPB Attributes (Filters)

When a memory is recorded it includes all of the **I**ntensity, **C**olour, **P**osition and **B**eam (I C P B) attribute groups. You can choose to exclude attribute groups when a memory is played back. In the “Edit Memory” screen (see above), clicking an attribute group (**I C P B**) excludes that group from the playback. The selection applies to all cues in the cue-list.

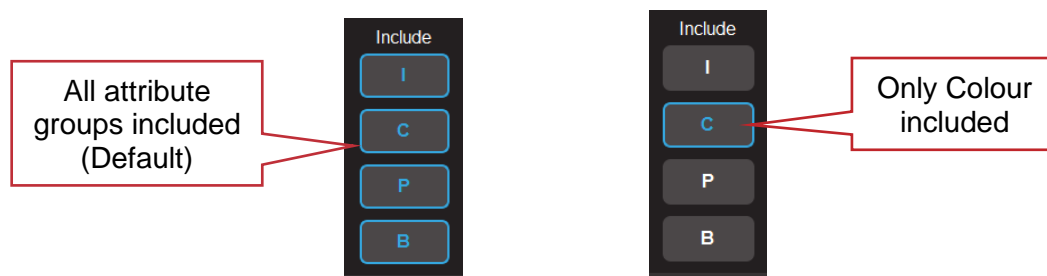

This is a powerful function because it allows you to independently playback groups of attributes of your fixtures.

For example, you have some fixtures that have intensity, colour and position attributes and you want to playback different combinations of colour, position and intensity. This is achieved by recording a cue-list (memory) then making a copy of that memory. Both cue-lists are then filtered so that one plays back only colour, and the other plays back only position and intensity.

1. Record a cue-list that has 5 different cues. Each cue has a different position and different colour.
2. Use the “Copy Memory” button (see below) to make a copy of the cue-list.
3. Edit the first cue-list and click I, P and B leaving only C (colour) included. This is now a colour cue-list.
4. Edit the second cue-list and click C and B leaving only I and P (intensity and position) included. This is now an intensity and position cue-list.

Playing the Intensity and Position cue-list steps the fixtures through the 5 positions without affecting the colour. Playing the Colour cue-list steps the fixtures through the 5 colours without affecting the position or intensity.

This gives you 25 possible combinations of colour and position from 5 cues.

14.11 Delete Cue

To delete a cue(s) in a cue-list, select the cue in the “Edit Memory” screen (see above) then click **Delete Cue**. To delete a memory that contains only a single cue, use “Delete Memory” below.

14.12 Delete Memory

To delete a memory, in the “Edit Memory” screen (see above) click **Delete Memory**. If the memory contains a single cue or a cue-list the entire memory will be deleted.

14.13 Chase

If a memory contains a cue-list you can choose to use it as either a “List” where you manually playback the cues or use it as a “Chase” where it automatically steps through the list at a rate that you set.

To change a cue-list into an automatically stepping “Chase”, in the “Edit Memory” screen (see above) click **Use as Chase**. The list will automatically increment through the steps using the speed and crossfade settings that you set.

Click the tabs to set the speed, crossfade and direction of the chase.

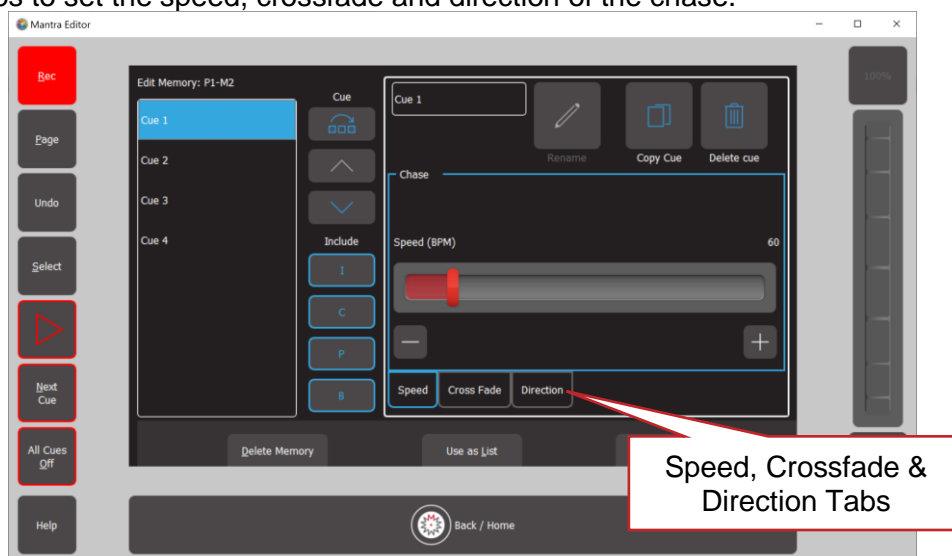

Speed Tab:

Use the slider or the + and – buttons to adjust the speed in BPM (Beats Per Minute).

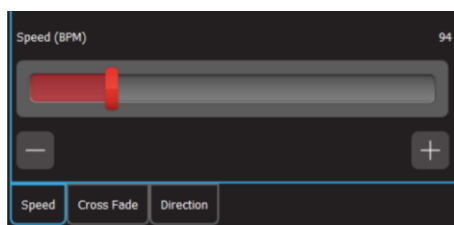

Crossfade Tab:

Traditionally chases will snap (instantly switch) from step to step but you may also set a “Cross Fade” value so that it will fade from step to step. Use the slider or the + and – buttons to adjust the % (percentage) of the step time that is used for the crossfade.

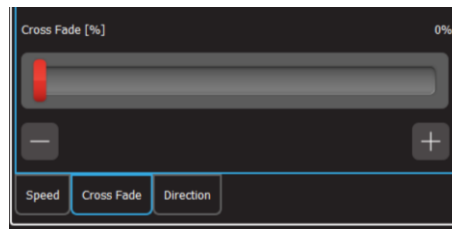

For example, if the chase speed is set at 60 BPM (which is one step per second), then with crossfade set at 0% (that is, no fade), the chase will wait for one second, then snap to the next step. None (0%) of the available speed time will be used for crossfading.

If the crossfade is set to 50%, then the chase will perform a 0.5 second crossfade to the next step, wait for 0.5 seconds and then perform the next crossfade. That is, 50% of the time is used to perform a crossfade and 50% of the time is spent waiting before starting the next crossfade.

If the crossfade is set to 100%, then the Chase will use all of the time performing a crossfade to the next step. When the crossfade is complete, the next crossfade will commence immediately.

Direction Tab:

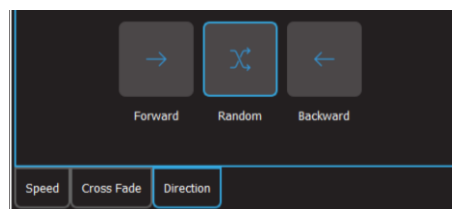

The choices are, **Forward**, **Random** or **Backwards**.

Chases automatically stop when their Playback is faded down.

To change a chase back to a cue-list click **Use as List**.

14.14 Edit (Update) Attributes of a Cue

To edit the intensity, colour, position or beam attributes of a fixture in a cue, perform the following steps:

- Clear all current output by clicking **Apps**, **Clear All** and **All Cues Off**
- Play the cue to be edited
- To edit the intensity of a fixture, select the fixture then move the Intensity wheel. When the wheel level matches the level in the cue, the wheel will take control of the intensity. Set the intensity to the required level.
- To edit colour, position or beam attributes of a fixture, select the fixture(s) then use the appropriate App (colour, position or beam) to make the change.

To update the cue, click **Rec** then **click and HOLD** (for 1 second) the playback displayer which contains the cue. The cue will be overwritten with the edited values.

14.15 Edit Animations and Shapes

Recorded animations and shapes cannot currently be edited (future feature).

If you need to change an animation or shape recorded in a cue, create a new animation or shape then overwrite the existing cue by clicking **Rec** then **click and HOLD** (for 1 second) the playback displayer which contains the original cue.

15 Schedule Playback

15.1 Overview

Playback from the Mantra Mini can be internally controlled by a day/date time schedule. The Schedule contains a list of events. Each event fades up or fades down a memory (a cue) at either a specific time of the day or every day or on certain days of the week or on particular date(s).

For example, turn the lights on at 9am Monday to Saturday and off at 6pm Monday to Friday and at 12 noon on Saturday.

The astronomical clock allows turning the lights on/off at sunrise/sunset, or any time before or after with a simple time offset (for example, Sunset + 30 minutes).

15.2 Add a Scheduled Event

To create a new scheduled event, click **Tools, Setup, Schedule**. The Schedule screen is only available when 1 or more cues have been recorded.

- If the Mantra Editor is not connected to a Mantra Mini, the screen shows the “Local Time” (the current time of your computer).
- If the Mantra Editor is connected to a Mantra Mini (by saving a show to or loading a show from the Mantra Mini), the screen shows the “Local Time” and the “Remote Time” (the current time of the Mantra Mini clock).

The Mantra Editor sets its clock from the computer or tablet on which it is running. When the Mantra Editor is connected to the Mantra Mini it sets the Mantra Mini clock to the same time but the Mantra Mini applies its own “Time Zone” and “Daylight Savings” settings from its “Time Settings” screen. Therefore, it is possible for the Mantra Editor time (Local Time) and the Mantra Mini time (Remote Time) to be set to different time zones. If the times differ, the “Remote Time” blinks red, warning you of the difference. Different time zones and daylight savings settings can cause unexpected results when programming and testing scheduled events because the Mantra Mini clock has a different time to your local computer.

When testing scheduled events, ensure that the both the computer running Mantra Editor and the Mantra Mini are set to the time zone for the location where the Mantra Mini is installed and to the same daylight savings settings.

To set the time zone and daylight savings in the Mantra Mini see section 18.13.

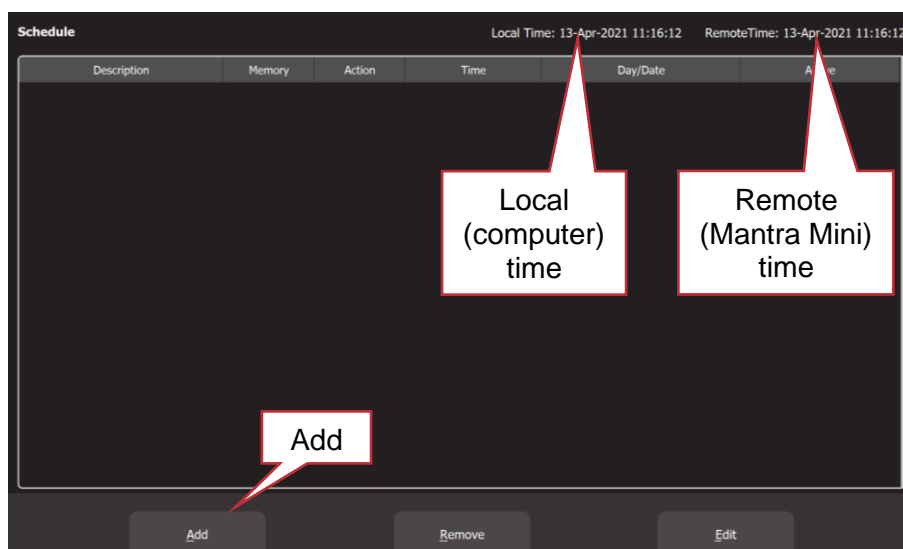

Schedule

To create a new event click **Add**.

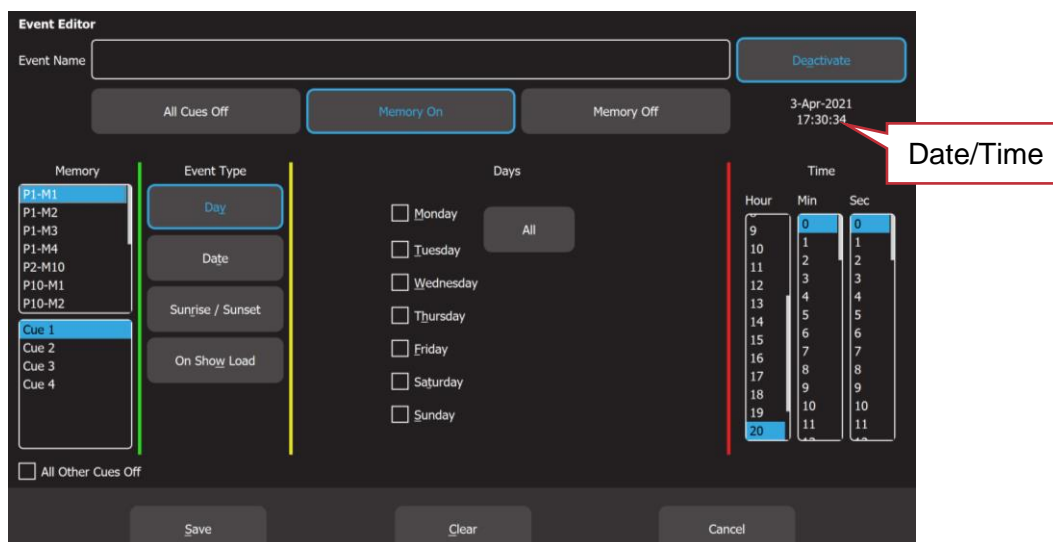

Event Editor

- When the Mantra Editor is not connected to the Mantra Mini, the “Event Editor” shows the date and time settings of the computer running the Mantra Editor (Local Time).
- When the Mantra Editor is connected to the Mantra Mini, the “Event Editor” shows the date and time settings of the Mantra Mini (Remote Time). If the Mantra Mini time is different to the local (computer) time the date/time blinks red as a warning. See above.

Enter a descriptive name for the event in the “Event Name” pane at the top.

The “Memory” pane on the left of the screen contains a list of all recorded memories and the cues in each memory.

Click on a memory and cue to select it to be played by the event.

When the event is played it can perform the following functions:

- **Memory On.** Fades up the selected the Memory / Cue Number
- **Memory Off.** Fades down the selected the Memory / Cue Number
- **All Cues Off.** All active Memories are faded down

For example, in one event, memory P1-M1 Cue 1 is set to “Memory On” at 0800 hours every day and in another event the same memory is set to “Memory Off” at 1700 hours every day.

All Other Cues Off. If the box is ticked, when the event is triggered, it will fade up the selected Memory / Cue Number and also fade out down any other active cues.

The “Event Type” pane allows you to select what will trigger the event. Click on the type of event that you require. The choices are:

15.2.1 Day

Day allows you to select the days of the week and the time at which the event will occur.

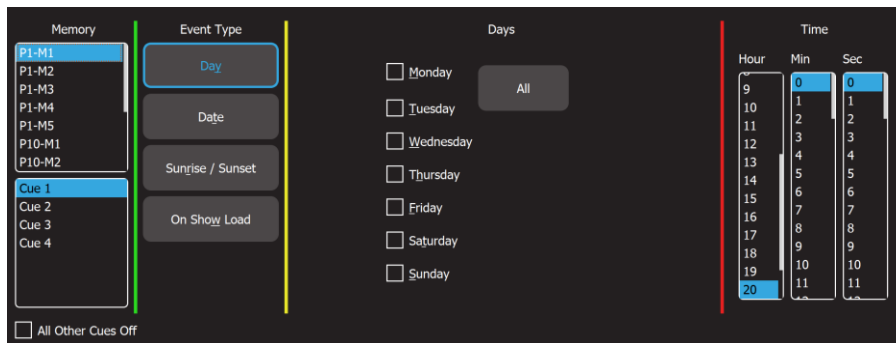

Day Event

15.2.2 Date

Date allows you to select a date from the calendar and the time at which the event will occur.

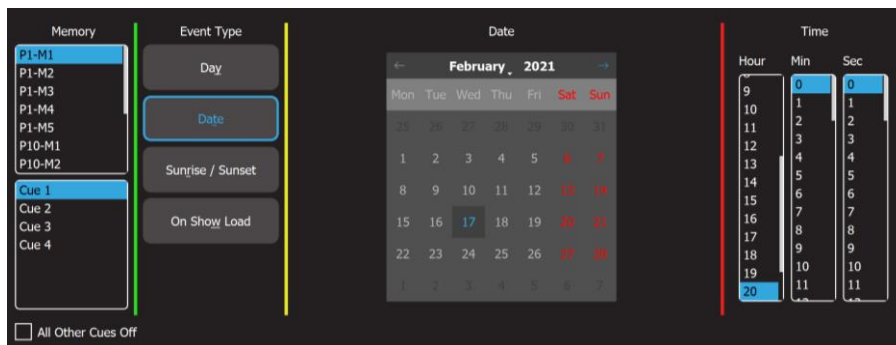

Date Event

15.2.3 Sunrise/Sunset

Sunrise / Sunset allows you to select either sunrise or sunset for the event. You can also set any time before or after sunrise or sunset with a time offset. For example, 30 minutes after Sunset.

Note: Mantra Mini must know its location so that the astronomical clock knows when sunrise/sunset will occur. If Sunrise / Sunset is greyed out, set the location (Latitude and Longitude) in the “Time Settings” screen. See section 18.13.

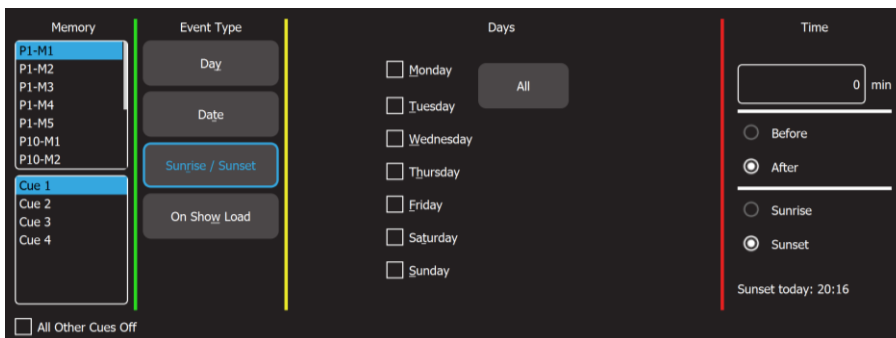

Sunrise/Sunset Event

15.2.4 On Show Load

On Show Load will playback the selected cue when the Mantra Mini powers up or when it automatically re-starts after the Mantra Editor is dis-connected.

15.3 Save Event / Deactivate Event

To save the event in the schedule click **Save**.

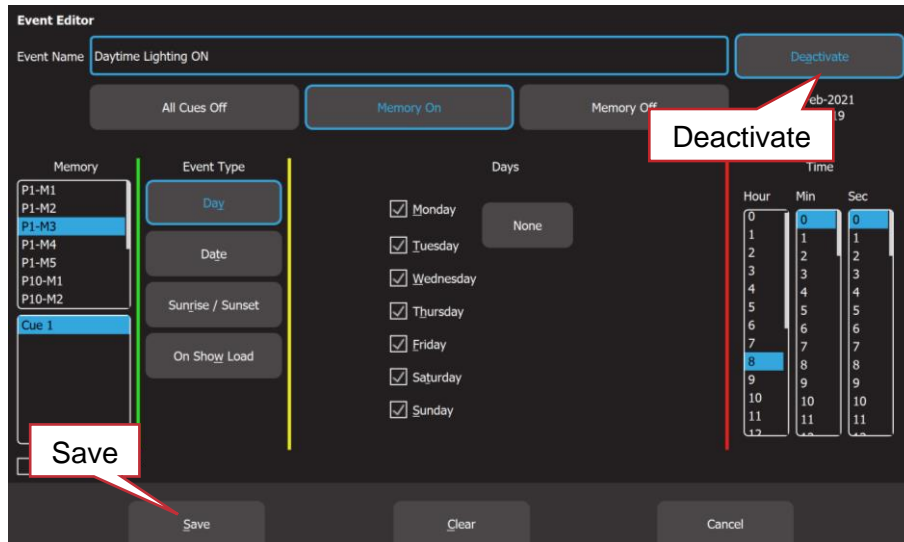

The “Schedule” screen shows the saved events.

Description	Memory	Action	Time	Day/Date	Active
Cyan On		On	09:30:00	Everyday	Active
Magenta On	P1-M5	Cue 1 On	10:30:00	Everyday	Active
Yellow On		On	11:30:00	Everyday	Active
Start LED Chase		On		Start on Show Load	Active

A saved event can be prevented from being played. Click on the event then click **Edit**. Click **Deactivate** then **Save**.

Description	Memory	Action	Time	Day/Date	Active
Day Lights ON	P1-M4	Cue 1 On	08:00:00	Everyday	Inactive

16 Remote Trigger Playback

16.1 Overview

The Mantra Mini can be controlled by “Remote Trigger Inputs” and it can also send messages to other devices by “Remote Trigger Outputs”.

There are 4 “message types” of remote trigger inputs available:

- Contact closures via the 3 “Isolated Inputs”
- OSC (Open Sound Control) via Ethernet or Wi-Fi
- UDP (User Datagram Protocol) via Ethernet or Wi-Fi
- TCP (Transmission Control Protocol) via Ethernet or Wi-Fi

These message types can be used to perform any of the following “Actions”:

- Play Memory (with the option to turn all “Other Cues Off”)
- Next Cue
- All Cues Off
- Override (enable/disable)
- Evac Mode (enable/disable)

There are 2 types of remote trigger outputs available:

- OSC
- UDP

Output remote triggers can be used to send a “Cue Change” message to another device. See section 16.5.7

16.2 Add a Remote Trigger

To open the Remote Triggers screen, click **Tools, Setup, Remote Triggers**.

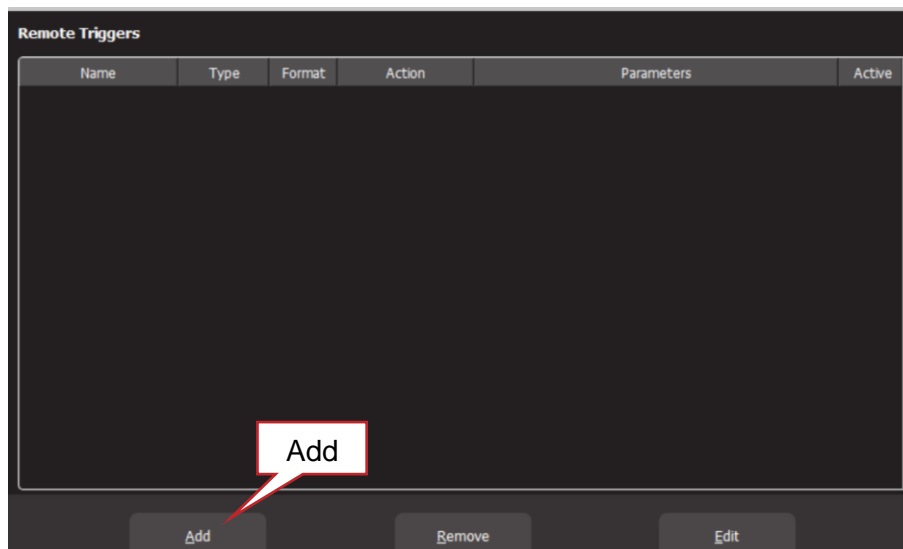

Remote Triggers

To create a new remote trigger click **Add**.

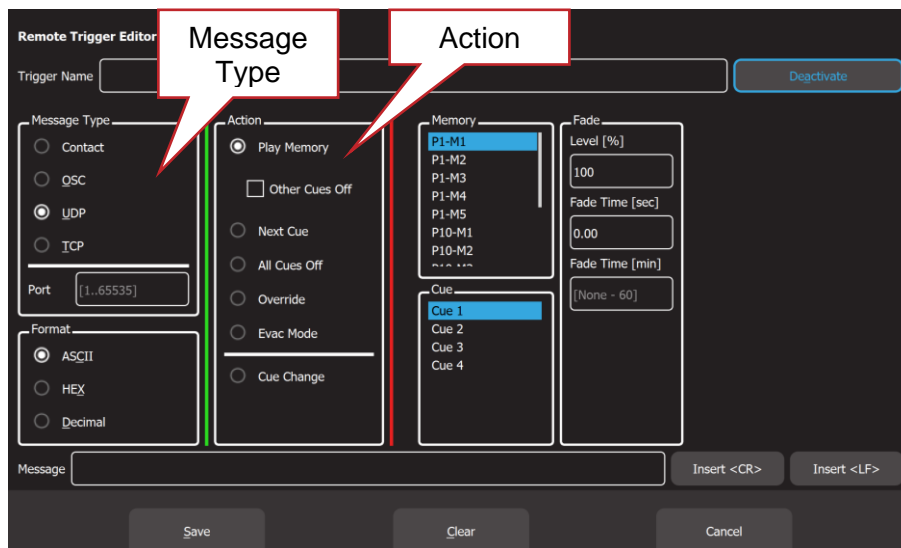

Remote Trigger Editor

Enter a descriptive name for the trigger in the “Trigger Name” pane at the top.

Select the “Message Type” of remote trigger:

- Contact (3 x “Isolated Input” contact closures). See section 16.3
- OSC (Open Sound Control). See section 16.4
- UDP (User Datagram Protocol). See section 16.5
- TCP (Transport Control Protocol). See section 16.5

Select the “Action” that you want the message to perform:

- Play Memory. See section 16.5.1
- Next Cue. See section 16.5.3
- All Cues Off. See section 16.5.4
- Override (enable/disable). See section 16.5.5
- Evac Mode (enable/disable). See section 16.5.6

Select or enter all the parameters for the selected “Action” as described below then click **Save**.

16.3 Contact (Isolated Inputs) Remote Triggers

The 3 isolated (voltage free) connector inputs on the front of the Mantra Mini can be connected to contact closures to control the Mantra Mini. They are primarily designed to activate and deactivate emergency evacuation (EVAC) lighting but can also be used to disable “Override” mode or playback any cue. There are 3 “Contact Modes” of contact closure operation (Toggle, Latch and On) to suit the different “Actions” that you select.

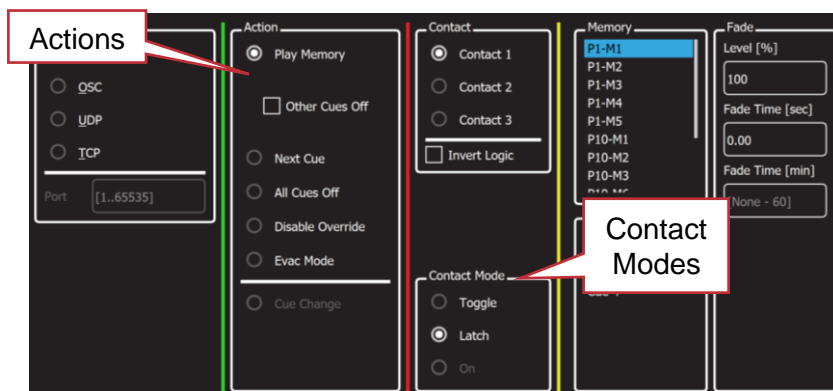

“Play Memory” action offers two choices of contact mode.

“Toggle” Contact Mode.

Contact closed = Memory fades up to selected level. Contact opened = No action.
 Contact closed = Memory fades down. Contact opened = No action

“Latch” Contact Mode.

Contact closed = Memory fades to selected level. Contact opened = Memory fades down.

See section 16.5.1 for more information on “Play Memory”.

“Next Cue” action has a fixed contact mode.

Contact closed = Advance to next cue. Contact opened = No action.

See section 16.5.3 for more information on “Next Cue”.

“Disable Override” action offers two choices of contact mode.

“Toggle” Contact Mode.

Contact closed = Override is disabled. Contact opened = No action.
 Contact closed = Override is enabled. Contact opened = No action.

“Latch” Contact Mode.

Contact closed = Override is disabled. Contact opened = Override is enabled.

See section 16.5.5 for more information about disabling “Override”.

See section 18.5.3 for more information on the “Override” function.

“Evac Mode” action offers two choices of contact mode.

“Latch” Contact Mode

Contact closed = EVAC Mode is activated. Contact opened = EVAC Mode is de-activated.

“On” Contact Mode

“On” mode requires one contact closure to turn On Evac lighting and a different contact closure to turn off Evac lighting.

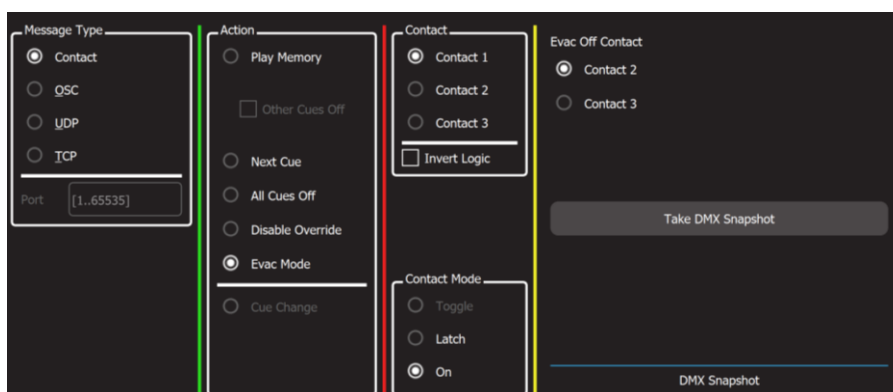

Select a “Contact” to turn on Evac Mode lighting. A contact closure of any duration enables Evac mode and leaves it enabled. This is to ensure that even if the external contact that triggered the “On” command fails, the Evac lighting state remains active. Select a “Evac Off Contact”. A momentary contact closure will turn off “Evac Mode”.

Note: The “Evac Off Contact” will not turn EVAC mode off if the “On” contact closure is still closed.

See section 16.5.6 for more information on “Evac Mode”.

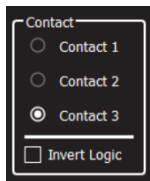

“Invert Logic” tick box.

When ticked, the contact closures become logically inverted. Click this box when the external contact closure is normally closed and opens to activate the remote trigger.

Note: Each contact can only be used for one remote trigger. If a contact has been used it will be “greyed out” and cannot be selected for another function.

16.4 OSC Remote Triggers

OSC (Open Sound Control) is a protocol for real time control between computers and multimedia devices. OSC messages sent from an OSC controller can be used to control the Mantra Mini. Mantra Mini can also send OSC messages to acknowledge whenever the level of any recorded cue changes. See section 16.5.7

In the “Remote Trigger Editor” screen (see above), enter a descriptive name for the trigger in the “Trigger Name” pane at the top.

To use OSC, Mantra Mini needs to know the “Port Number” that is used by the the device sending the OSC message. If the sending device uses a specific port number, then enter the same port number in the Mantra Mini. If not, choose a random port number in the range 1 to 65535 and enter the same number in the sending or receiving device and the Mantra Mini.

Mantra Mini will respond to an OSC message and follow the instructions contained in the message to either “Play Memory”, advance to “Next Cue”, “All Cues Off” or enable/disable “Override” or enable/disable “Evac Mode”. These actions are all described below and also in their own sections as referenced at the end of this section.

To assist you in programming the OSC messages into your OSC controller, when you select a type of “action”, the Mantra Mini shows you the message it needs to receive for that action. This allows you to simply copy that message into your OSC controller and edit the message, if necessary, as described below.

“Play Memory” Action.

When you select a “Play Memory” action, the message pane shows you a template for the OSC message that is required to play a memory with variables that you can replace with actual values.

Click and drag in the message pane to select the message template then copy and paste the message into your OSC controller.

The template is:

/PlayMemory/Page=\$p/Memory=\$m/Cue=\$c/Level=\$l/Fade=\$t

The variables are:

\$p	Page Number (1-10)
\$m	Memory Number (1-10)
\$c	Cue Number (1-...)
\$l	Level (0-100)
\$t	Fade time in milli seconds (0-...) 1 second = 1000 milli-seconds

The “Fade Time” is the time for the Page/Memory to fade up or down to the level set by the “Level” value when triggered by the message. Every cue also has its own “Fade In” and “Fade Out” time as set when the cue is recorded or edited. If you want to play a cue using only an OSC fade time, it is advisable to set the cues own “Fade In” and “Fade Out” times to 0 seconds so that the OSC fade time is the only time that affects the cue. If you want to play a cue using only the cues fade time it is advisable to set the OSC fade time to 0 seconds so that the cue fade times are the only times that affects the cue.

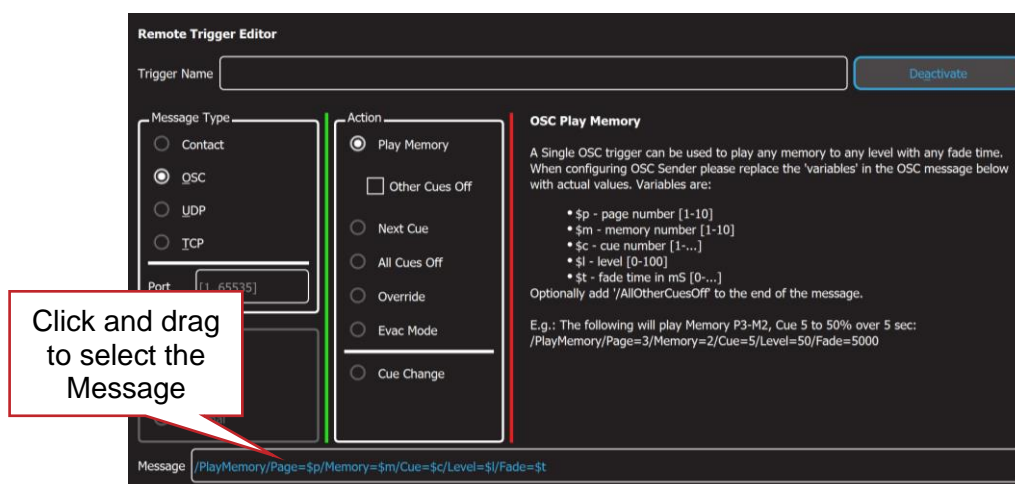

In your OSC controller, edit the pasted OSC message by replacing each of the “\$variables” with the actual values that you require for the trigger.

For example, to play Page 1, Memory 2, Cue 3 at a level of 100% with a fade time of 4 seconds, the OSC message becomes:

```
/PlayMemory/Page=1/Memory=2/Cue=3/Level=100/Fade=4000
```

To fade down the cue, send an OSC message with a level of 0%:

```
/PlayMemory/Page=1/Memory=2/Cue=3/Level=0/Fade=4000
```

Note: Only one OSC “Play Memory” Remote Trigger is allowed to be saved but it can be used to play any memory to any level. When you have saved an OSC “Play Memory” Remote Trigger, Mantra Mini listens for all OSC “Play Memory” messages. Each received message contains the instructions for the memory to play including its level and fade time so only one remote trigger is required.

Note: OSC messages always use memory numbers and cue numbers. Mantra Mini allows you to rename memory numbers and cue numbers. If a memory or cue has been renamed, the OSC message must still use the original memory number and cue number.

For example;

If “Cue 3” was renamed “Blue Wash”, the OSC message must still use the name “Cue 3”.

If “P1-M1” was renamed “Act1”, the OSC message must still use the name “P1-M1”.

See section 16.5.1 for more information on “Play Memory”.

“Next Cue”, “All Cues Off”, “Override” and “Evac Mode” Actions

When you select a “Next Cue” or “All Cues Off” action, then select a Memory or when you select either “Override” or “Evac Mode” actions and select either “Enable” or “Disable”, the message pane shows you the actual OSC message that is required to trigger the action.

Click and drag in the message pane to select the message, then copy and paste the message into your OSC controller.

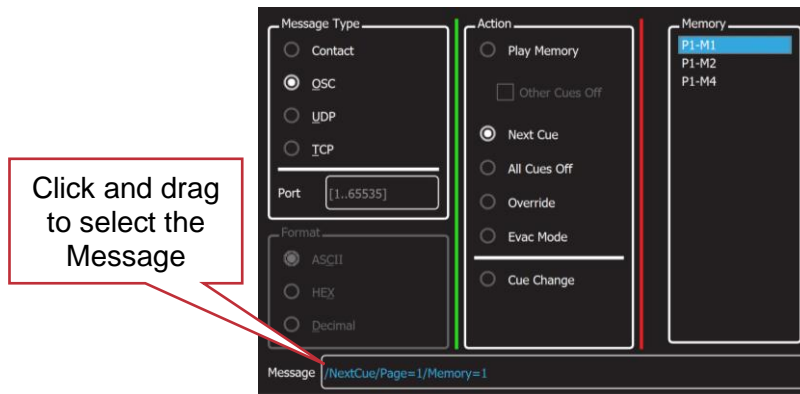

- See section 16.5.3 for more information on Next Cue
- See section 18.5.3 for more information on Override
- See section 16.5.6 for more information on Evac Mode
- See section 16.5.7 for more information on Cue Change

16.5 UDP and TCP Remote Triggers

UDP (User Datagram Protocol) and TCP (Transport Control Protocol) are Internet protocols and can be used to send messages to control the Mantra Mini. Many third-party control systems can send UDP or TCP messages and hence be used to control the Mantra Mini.

Mantra Mini can also send UDP or TCP messages to other devices to acknowledge whenever the level of any recorded cue has changed and hence that the received message has been executed. See 16.5.7

In the “Remote Trigger Editor” screen (see above), enter a descriptive name for the trigger in the “Trigger Name” pane at the top.

Mantra Mini needs to know the “Port Number” used by the the device sending the message. If the sending device uses a specific port number, then enter the same port number in the Mantra Mini. If not, choose a random port number in the range 1 to 65535 and enter it in the sending device and the Mantra Mini.

UDP and TCP messages can be sent in different formats. In the Mantra Editor, select the “Format” that is used by the sending device.

- **ASCII** (American Standard Code for Information Interchange)
- **Hex** (Hexadecimal)
- **Decimal**

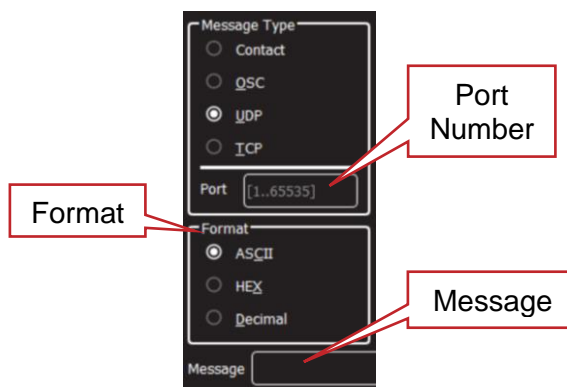

The TCP or UDP message that is sent from the controlling device can be any combination of text or numbers. This can be any descriptive text that you like. The message does not define any parameters of the action such as Memory Number, Cue Number, Level or Fade time. In the “Message” pane, enter the exact message that will be sent by the controlling device. When the received message exactly matches the message in the message pane, the action and parameters as set in the “remote trigger editor” screen will be triggered.

The actions that can be triggered are either “Play Memory”, advance to “Next Cue”, enable/disable “Override” or enable/disable “Evac Mode”. These actions are all described in their own sections.

- See section 16.5.1 for more information on Play memory
- See section 16.5.3 for more information on Next Cue
- See section 18.5.3 for more information on Override
- See section 16.5.6 for more information on Evac Mode

For example, the message might be “Foyer Lights On” and when received, it will trigger an action to “Play Memory, P1-M2, Cue 1 at 100% Level with a Fade Time of 0.

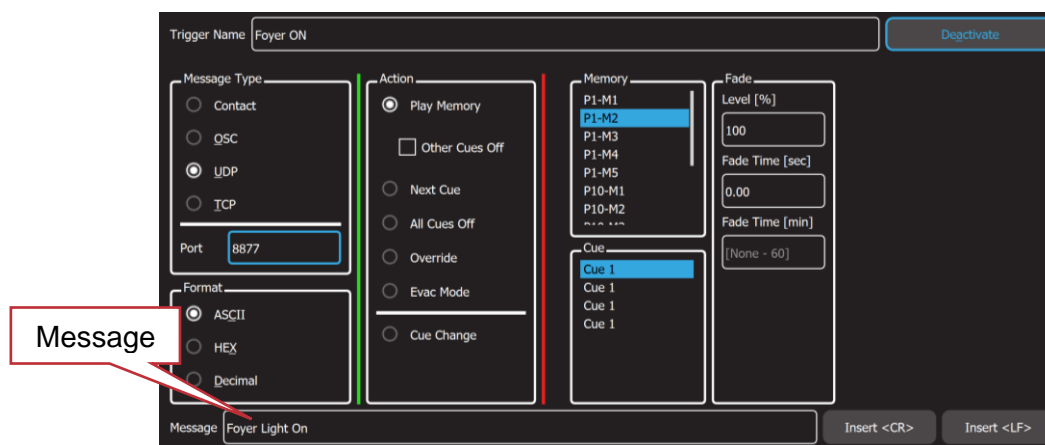

Some sending devices will automatically include a <CR> (Carriage Return) or <LF> (Line Feed) at the end of each message. If the sending device ends the message with a CR or LF, you must also include these in the message pane because the message that you enter must exactly match the message that is sent by the transmitting device.

A <CR> or <LF> cannot be typed directly into the message pane. To insert a Carriage Return or Line Feed into the message pane, click either **Insert <CR>** or **Insert <LF>**.



A CR or LF are also used to separate consecutive messages. This allows the Mantra Mini to recognise each separate message and it can then use them in separate triggers.

Hint: Adding a <CR> or <LF> to end of each message is not mandatory but it is good practise. They allow the Mantra Mini to always knows that the message has ended.

16.5.1 Play Memory.

“Play Memory” is an “Action” that can be triggered by any of the 4 “Message Types” (Contact, OSC, UDP, TCP). The 4 message types are described above. When the “Play Memory” action is triggered it will play the selected cue.

- OSC messages will play a memory/cue using the parameters in the OSC message. See section 16.4
- Contact, UDP and TCP messages will play the selected memory/cue using the parameters in the remote trigger screen. See section 16.5

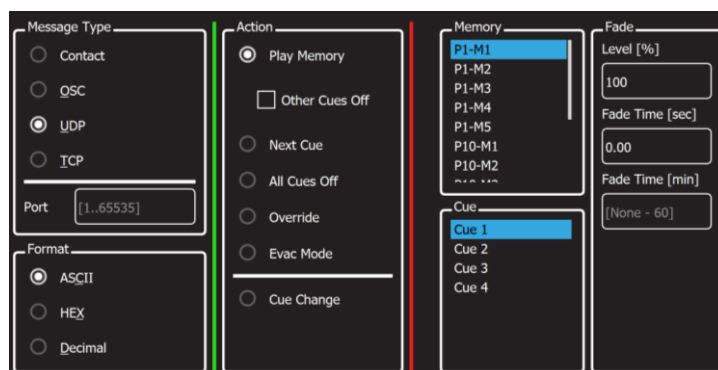

- To fully fade up a memory use a trigger with the Fade Level set to 100%
- To fade down a memory use another trigger with the Fade Level set to 0%

If the “Message Type” is set to “Contact” and the contact mode to “Toggle”, the memory can be toggled on and off with a single contact closure trigger that has the Fade set to 100% (or any other level). The memory is faded up to the set level on the first contact closure and faded down on the next contact closure. See section 16.3

The “Fade Level” in the Play Memory trigger is the level for that playback (page/memory).

The “Fade Time” in the Play Memory trigger is the time for the playback (page/memory) to fade up or down when triggered by the message. Every cue also has its own “Fade In” and “Fade Out” time as set when the cue is recorded or edited. If you want to play a memory using a Remote Trigger fade time, it is advisable to set the cues own “Fade In” and “Fade Out” times to 0 seconds so that the Remote Trigger fade time is the only time that affects the cue. If you want to play a memory using the cues fade time it is advisable to set the Remote Trigger fade time to 0 seconds so that the cue fade times are the only times that affects the cue.

Hint: Remote triggers can be used to play a single cue at different levels and with different fade times. For example, a memory might contain the cue for “House Lights”. One trigger might fade up the cue to 100% level over 5 seconds. Another trigger might fade the same cue to 50% level over 20 seconds.

Hint: If a memory/cue-list is set to play as a chase, using a Remote Trigger fade time will fade up or down the running chase.

16.5.2 Other Cues Off

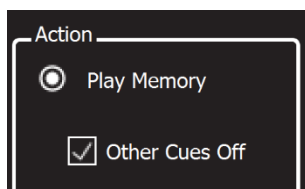

“Other Cues Off” is a tick box option that is available when a “Play Memory” action is selected. If “Other Cues Off” is ticked, playing the selected memory will also fade out all other active cues.

16.5.3 Next Cue

“Next Cue” is an “Action” that can be triggered by any of the 4 “Message Types” (Contact, OSC, UDP, TCP). The 4 message types are described above.

“Next Cue” plays the next cue in the selected memory.

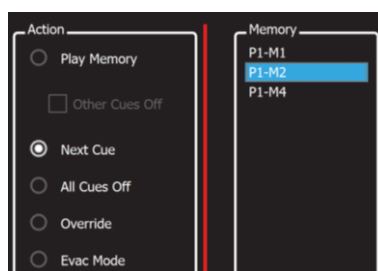

For example, memory P1-M2 (Page 1- Memory 2) contains a cue-list of 5 cues. Cue 2 is currently active. A “Next Cue” action on P1-2 will advance the cue-list to cue 3.

- If the memory is not currently faded up, “Next Cue” advance to the next cue and will fade it up to 100% level.
- If the memory is faded up, “Next Cue” will advance to the next cue and maintain the current fade level.

16.5.4 All Cues Off

“All Cues Off” is an “Action” that can be triggered by any of the 4 “Message Types” (Contact, OSC, UDP, TCP). The 4 message types are described above. When the “All Cues Off” action is triggered, it will fade out all active cues.

16.5.5 Override Disable

“Override” is a function where a DMX-512, Art-Net or sACN input signal from another lighting console “overrides” the Mantra Mini’s own output. Override is configured in the “Universes” screen. See section 18.5.3.

Override can be prevented from occurring by a Remote Trigger.

“Override” is an “Action” that can be triggered by any of the ethernet “Message Types” (OSC, UDP, TCP). It can be set to “Enable” or “Disable”.

OSC, UDP, TCP

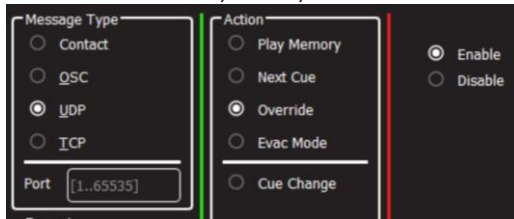

“Disable Override” is an “Action” that can be triggered by a “Contact” Message Type. See section 16.3

Contact

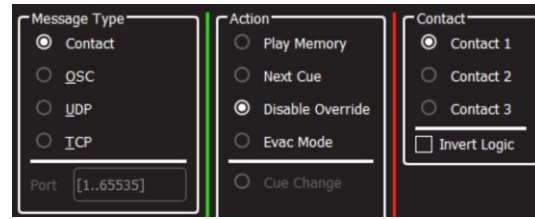

- When “Override” is disabled, it will prevent override from occurring, even if it has been activated in the “Universes” screen
- When “Override” is enabled, it will allow override if it has been activated in the “Universes” screen

16.5.6 Evac Mode

“Evac mode” is an “Action” that can be triggered by any of the 4 “Message Types” (Contact, OSC, UDP, TCP). The 4 message types are described above. Evac mode provides emergency evacuation lighting by activating a special lighting memory (see “Take DMX Snapshot” below) that turns on the necessary lighting to illuminate escape routes and obstacles.

Note: LSC strongly recommends that a contact closure is used to control Evac mode because in the event of a loss of power, the contact closure triggers become active very quickly after power is restored to the Mantra Mini whereas network commands take much longer to establish communications. Also see section 16.3

Evac mode can be activated by either a simple “Fire” or “Evacuate” button or can be connected to a BMS (Building Management System) so that the emergency lighting is automatically operated when a fire alarm is activated.

When evacuation lighting has been activated, some authorities require a separate contact closure to de-activate the evacuation lighting. This ensures that once triggered, the lighting remains on until it is deliberately turned off. See section 16.3, “On Contact Mode”.

It is also common for the regulations to require that in the event of a loss of power, the evacuation lighting is quickly reactivated when the power is restored (typically within 6 seconds). To achieve these requirements, the Mantra Mini uses a separate circuit to store the EVAC lighting memory and also to generate the DMX output signal. This allows DMX playback to be re-established very quickly after power up.

Note: Evac mode lighting signals can be output as DMX, sACN and ArtNet. LSC strongly recommends that the DMX output is used for evacuation lighting because in the event of a loss of power, the DMX outputs become active very quickly after power is restored to the Mantra Mini whereas sACN and ArtNet take longer to begin transmission.

Regulations and codes for evacuation lighting vary throughout the world. Please check the requirements of the local authorities where the Mantra Mini is installed.

When the Evac mode is activated, the Mantra Mini ignores all other playback commands and the internal playback schedule. This ensures that the EVAC mode lighting is absolute and cannot be overridden.

To create the Evac Lighting memory, use the Mantra Editor to turn on the lighting fixtures required for evacuation lighting then save the lighting state by clicking **Take DMX Snapshot**.

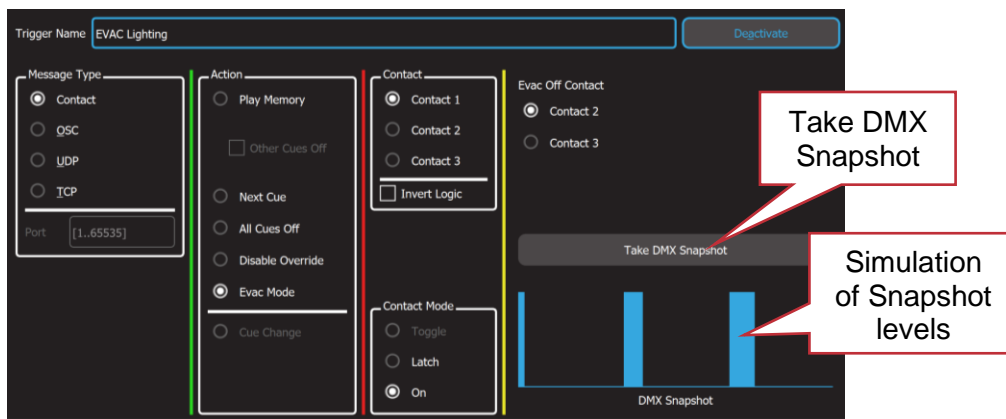

See section 16.3 for more details about using contact closures to trigger Evac mode.

16.5.7 Cue Change

“Cue Change” is a Remote Trigger Output.

Whenever the level of any recorded cue changes on the output, a message can be sent via OSC or UDP. This can be used to send a message back to a controlling device, confirming that the Mantra Mini has responded to a remote trigger input.

Mantra Mini needs to know the “Port Number” used by the the device receiving the message. If the receiving device uses a specific port number, then enter the same port number in the Mantra Mini. If not, choose a random port number in the range 1 to 65535 and enter it in the receiving device and the Mantra Mini.

In the “Destination Address” pane, enter the IP address to which the message is to be sent.

“UDP” Cue Change Messages have a flexible format and “OCP” Cue Change Messages have a fixed format. The different formats are described below.

“UDP” Cue Change Messages.

In the “Message” pane, type in the outgoing message. You can enter any message text that you like. The following “variables” can be included in the outgoing message:

\$Variables	Parameter
\$n	network name
\$m	memory number [1...100]
\$c	cue number
\$l	level [%]
\$t	fade time [ms]

When the message is sent, the “\$variables” in the message will be automatically replaced with the actual values from the memory that changed level.

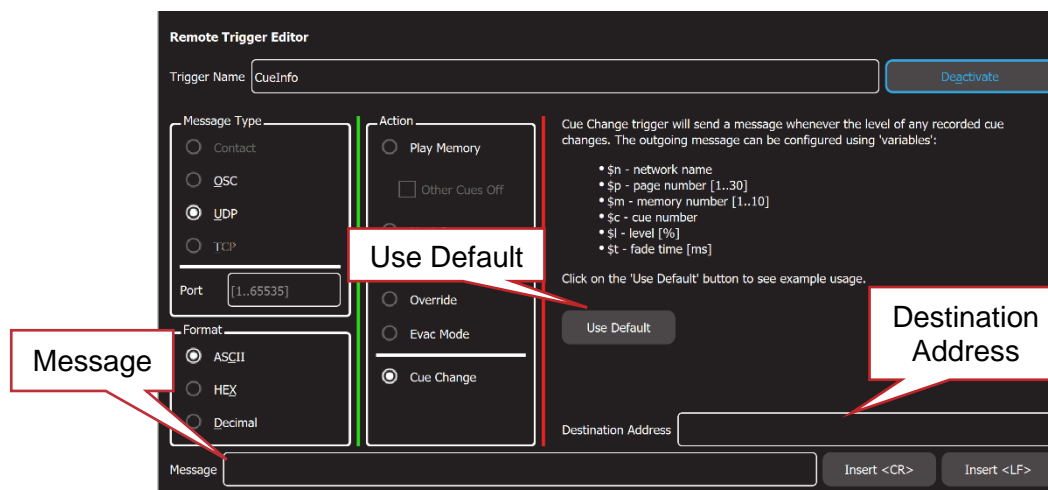

If you click **Use Default**, the message pane will show a sample message.
 Mantra:::CueInfo:::\$n:::\$m:\$c:::l=\$l%:::t=\$tms

For example,
 Memory 1, Cue 1 has the foyer lights at a level of 100%. If you define the “Cue Change” message as:

“Foyer/Memory=\$m/Cue=\$c/Level=\$l”.

When M1-C1 changes level to 100%, Mantra Mini will send the message:

“Foyer/Memory=1/Cue=2/Level=100”

“OSC” Cue Change Message.

The message pane shows the message that will be sent.

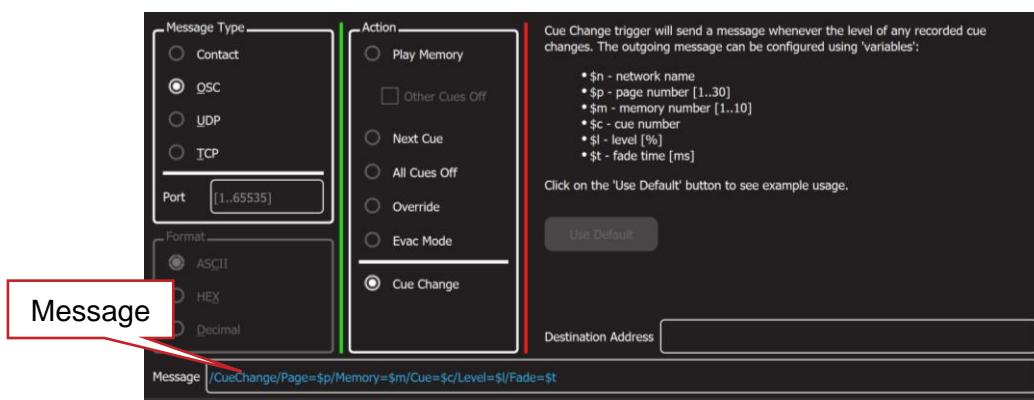

The message format is:

/CueChange/Page=\$p/Memory=\$m/Cue=\$c/Level=\$l/Fade=\$t

When the message is sent, the “\$variables” in the message will be automatically replaced with the actual values from the memory that changed level.

For example,

Memory M1-P1, Cue 1 has the foyer lights at a level of 100%. When M1-P1-C1 changes level to 100%, Mantra Mini will send the message:

/CueChange/Page=1//Memory=1/Cue=1/Level=100/Fade=0”

16.6 De-activate a Remote Trigger

To de-activate a Remote Trigger, from the home screen click **Tools, Setup, Remote Triggers.**

Click the remote trigger to select it then click **Edit.**

Remote Triggers

Name	Type	Format	Action	Parameters	Active
Evac Lighting	Contact #1	Latch	Evac	Latch	Active
Play P1-M1	UDP	ASCII	Play Memory	P1-M1 to 100% over 0 sec	Active
P1-M1 next cue	UDP	ASCII	Next Cue	P1-M1	Inactive
P1-M1 Cue 3	UDP	ASCII	Jump to Cue	P1-M1 : Cue 1	Active

Edit

Add Remove Edit

To de-activate the Remote Trigger click **Deactivate**, then click **Save**.

Remote Trigger Editor

Trigger Name: P1-M1 Cue 3 Deactivate

Message Type: Contact Play Memory

Action: Play Memory

Memory: P1-M1 Cue: Cue 1

Deactivate

17 Show Files

17.1 Overview

A show file contains the recorded memories (cues and cue-lists), the patch, the playback schedule, the remote triggers and the rig view. “System Settings” such as time, network settings and language are not saved or recalled by show files but are stored internally in the Mantra Mini.

Show files can be saved to and loaded from the Mantra Mini from the computer or tablet running the Mantra Editor. A copy of the show file can also be stored in the Mantra Editor for back-up or off line editing. Show files can be loaded directly into a Mantra Mini from a USB memory stick.

Shows exported from a Mantra Lite console can also be imported into the Mantra Editor where schedule and/or remote trigger information can be added prior to loading the show into the Mantra Mini.

When a show has been saved or loaded in the Mantra Editor, the show name is shown in the top right corner of the home screen.

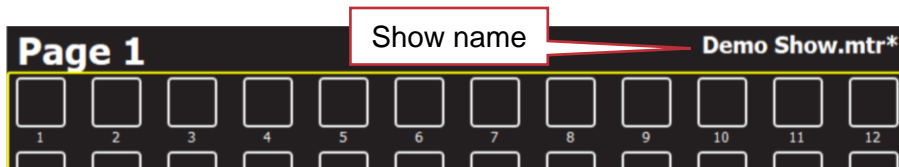

An * after the show name indicates that the current show has been changed but has not been saved.

When the Mantra Editor is connected to a Mantra Mini, the file name is preceded by the network name of the Mantra Mini. In the following example, the network name of the Mantra Mini is “Foyer MM”.



To start a new show or to save, load, import or export a show, from the “Home” screen click **Tools**.

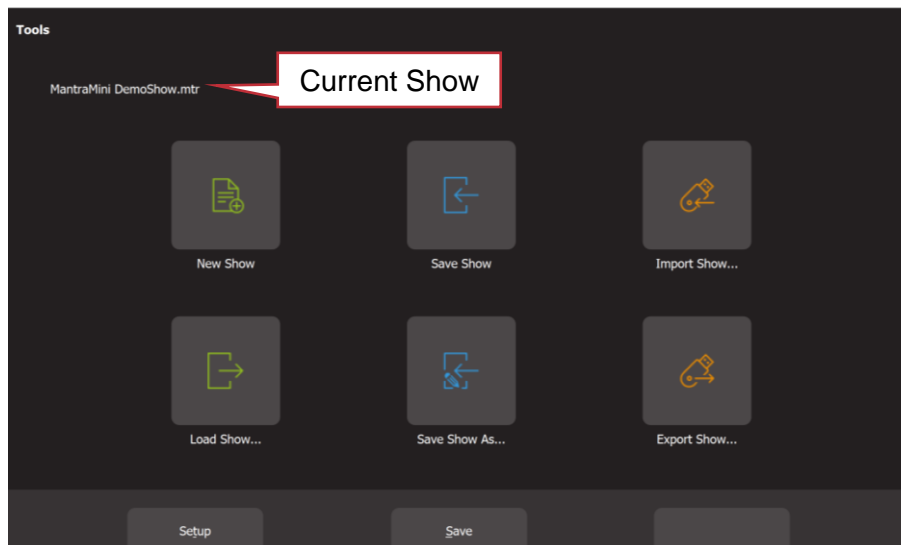

Tools Screen

The name of the current show or “new show” is shown at the top of the screen.

The “Tools” screen offers the following choices:

17.2 New Show

Selecting **Tools, New Show** will clear all memories and clear the patch. The Mantra Editor will also be disconnected from the Mantra Mini.

When starting a “New Show”, all fixtures need to be patched. See section 7.

17.3 Load Show, Save Show, Save As

Shows can be saved or loaded on the “Local” computer or tablet running the Mantra Editor or they can be saved or loaded on a “Remote” Mantra Mini that is connected to the computer or tablet via either Wi-Fi or a network cable.

17.3.1 Load Show

To load a show, click **Tools, Load Show**.

The screen shows the local (Mantra Editor) show files. To load a local show, click the show **name** then click **Load**. To load a show from a Mantra Mini, click **View Remote**.

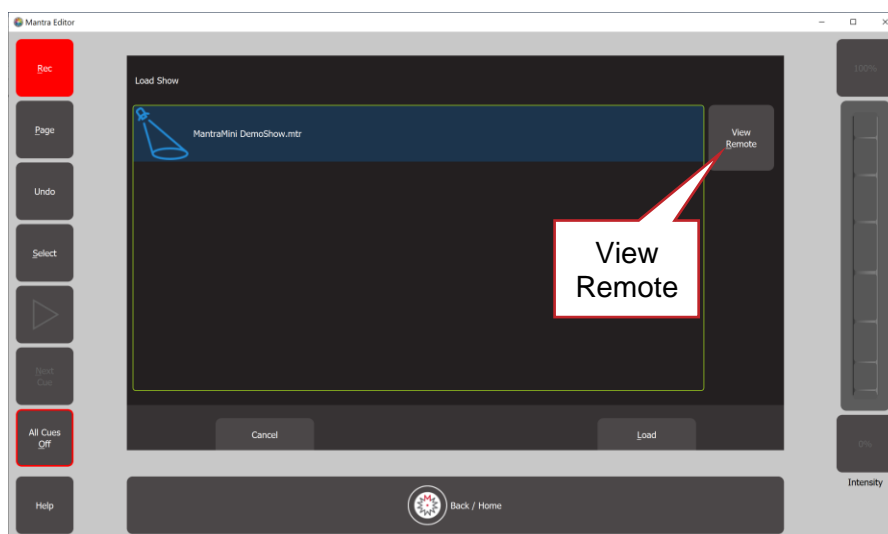

Multiple Mantra Minis can exist on the same network. When you click “View Remote”, each Mantra Mini is shown as a Mantra icon followed by the Mantra Mini’s network name then the name of the show that is currently loaded on the Mantra Mini.

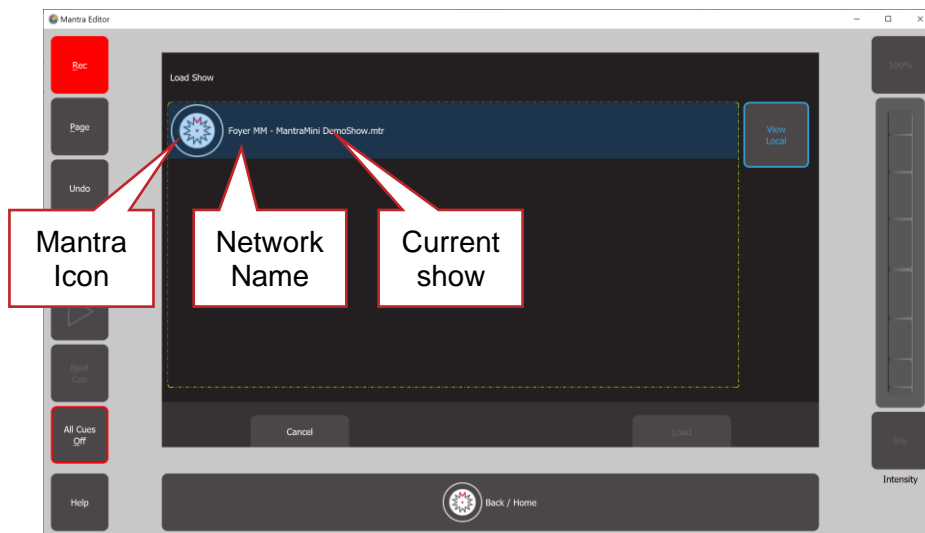

Click the Mantra Mini **icon** to open it. All of the shows that are saved in the selected Mantra Mini are displayed. Click a show **name** then click **Load**.

17.3.2 Save Show

To save a show, click **Tools, Save Show**.

If the Mantra Editor is connected to the Mantra Mini it will save directly to the Mantra Mini.

If the Mantra Editor is NOT connected to the Mantra Mini it will save to the Mantra Editor (computer).

Hint: When the Mantra Editor is connected to a Mantra Mini, the show name at the top of the home screen is preceded by the network name of the Mantra Mini.

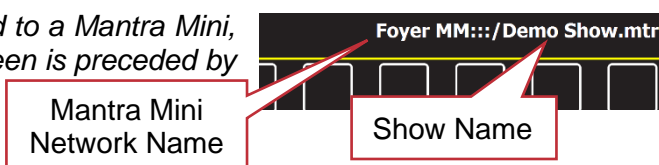

17.3.3 Save Show As

To save the current show with a new name (and hence keep the previous version), click **Tools, Save Show As**. The current show name has “_copy” automatically appended to its name but you can delete that name and enter any name that you like.

The newly named version of the show can be saved locally by clicking **Save** or in the Mantra Mini by clicking **View Remote**, clicking the Mantra **Icon** then **Save**.

17.4 Import Show

From the “Home” screen tap **Tools, Import Show**. This opens your computers file manager allowing you to load a show from any location including a USB memory stick. The show file will be opened in the Mantra Editor and also saved in the computer or tablet.

17.5 Export Show

From the “Home” screen tap **Tools, Export Show**. This opens your computers file manager allowing you to save the show in any location including a USB memory stick.

The USB stick must be formatted as FAT32.

17.6 Mantra Mini USB Show Load

A show can be loaded from a USB memory stick plugged directly into the Mantra Mini. This function allows a dealer or installer to email a new (updated) show file to a user and have them upload the replacement show file directly into the Mantra Mini, without using the Mantra Editor.

The new show file must be saved to a USB stick in a folder named “LSC”. The name of the new show file must exactly match (case sensitive) the name of the show file that is currently loaded on the Mantra Mini.

Note: The LSC folder on the USB stick should only contain show files. If the LSC folder contains a software update file as well as a show file, the software update will take precedence

When the new file is loaded, it is saved with the same name, thus replacing the original show file. The original show is automatically renamed in the Mantra Mini with “_overwrittenTimeDate” appended to its name so that it can be used for archival purposes.

To load a show from a USB stick into the Mantra Mini, perform the following steps:

1. Create a folder named “LSC” on a USB memory stick.
2. Copy the show file into the “LSC” folder on the USB stick.
3. Insert the USB Stick into the Mantra Mini.
4. If a valid show file is found (exact name match required, see above), all the front panel LEDs will triple flash for 5 seconds. Press the **USER** button before they stop flashing to load the show
5. All the LEDs now slow flash to show that the file is uploading. If you don't press the USER button, the show load does not happen. If you do want to load the show but are too slow, remove the USB stick, wait a few seconds and then start again at (3).
6. DMX output is suspended during show load.
7. When the show load is completed, the Mantra Mini will automatically reboot then the front panel LEDs double flash (as they did in step 4).
8. Remove the USB stick to finish.

18 Setup Menu

18.1 Overview

To select the “Setup” screen, from the “Home” screen click **Tools, Setup**.

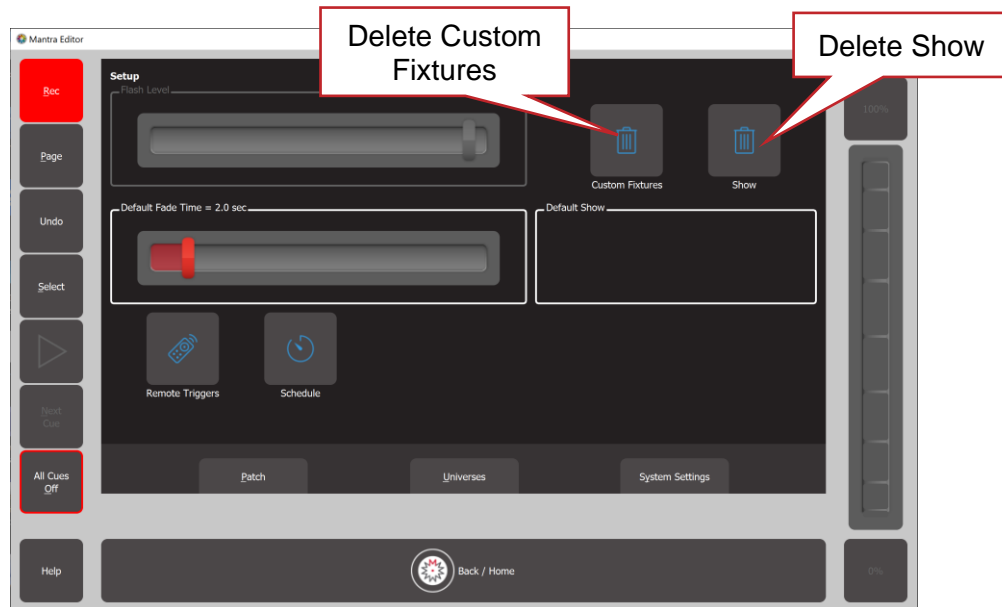

Setup

The Setup screen offers the following functions:

- Default Fade Time. See section 18.2
- Delete Custom Fixtures. See section 18.3
- Delete Show. See section 18.4
- Schedule. See section 15
- Remote Triggers. See section 16
- Patch. See section 7
- Universes. See section 18.5
- System Settings. See section 18.7

18.2 Default Fade Time

When a cue is recorded, the “Fade In” and “Fade Out” times will be the time value in the “Default Fade Time” setting. To change the default fade time setting, from the “Home” screen click, **Tools, Setup** then use the “**Default Fade Time**” slider.

18.3 Delete Custom Fixtures

The Mantra Mini uses the Carallon fixture library. This provides thousands of fixtures, however you can also create your own custom fixtures for any fixture or feature that is not in the Carallon library. See section 19. The **Custom Fixtures** (trash can icon) can be used to delete all custom fixtures in the library.

All custom fixtures are also saved in any show to which they are patched, so after deleting the custom fixtures, reloading any show that contained custom fixtures will automatically add those fixtures back into the custom library.

18.4 Delete Show

To delete a show file, from the “Home” screen click, **Tools, Setup, Show** (trash can icon).

A list of shows stored in the editor is shown. To see shows stored on a connected Mantra Mini click **View Remote** then click on the Mantra Mini.

Click the show **name** to be deleted then click **Delete**. To confirm the action, click **Yes**.

Note: Deleting a show cannot be un-done.

18.5 Universes

From the home screen click **Tools, Setup, Universes**. The “Input/Output Universe Mapping” screen has the following functions:

- Set the universes for sACN output and ArtNet output
- Activate/deactivate sACN output and ArtNet output
- Set the universes for sACN input and ArtNet input
- Activate/deactivate the sACN or ArtNet or DMX input that can override the output
- View the DMX output levels on Universe 1 and Universe 2

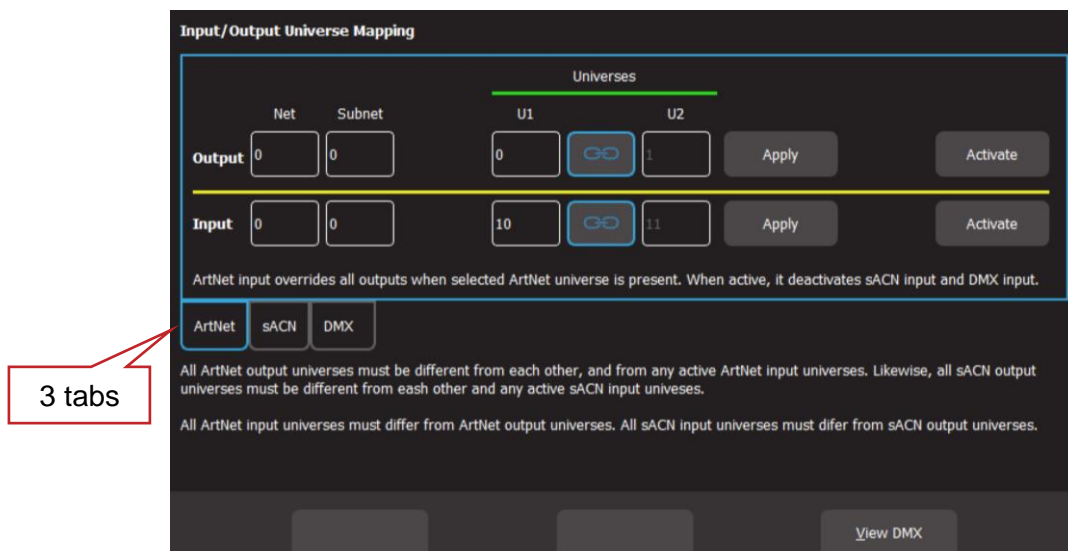

There are 3 tabs that can be selected, **ArtNet**, **sACN** and **DMX**.

The ArtNet and sACN tabs have settings for “Output” and “Input”.

The DMX tab only controls the DMX input.

Mantra Mini can transmit its DMX output as DMX512, sACN and ArtNet. The patch screen (see section 7) allows you to patch each fixture to either U1 (Universe 1) or U2 (Universe 2). These are output as DMX512 on the “Isolated DMX1 and “Isolated DMX2” connectors respectively.

The “Universes” screen allows you to map the U1 and U2 outputs of the patch screen to any sACN and ArtNet universes that you select.

The following rules apply when mapping sACN and ArtNet.

- All sACN output universes must be different from each other and from any active sACN input universes.
- All ArtNet output universes must be different from each other and from any active ArtNet input universes.
- All sACN input universes must differ from sACN output universes.
- All ArtNet input universes must differ from ArtNet output universes.

18.5.1 ArtNet Output

From the home screen click **Tools, Setup, Universes**, click the **ArtNet** tab.

ArtNet is a streaming protocol to transport multiple DMX universes over an Ethernet cable/network. Mantra Mini can transmit ArtNet from the Ethernet connector. Mantra Mini supports Art-Net v4 which is configured as 128 Nets (0-127) each with 16 Subnets (0-15), each containing 16 Universes (0-15).



ArtNet Output

Enter the Output “Net” and “Subnet” in their respective boxes.

In the “U1” box, enter the number of the ArtNet universe that is to be mapped to the fixtures that have been patched to U1 in the Patch screen.

In the “U2” box, enter the number of the ArtNet universe that is to be mapped to the fixtures that have been patched to U2 in the Patch screen.

Click **Apply**.

If the “Link” symbol between the U1 and U2 boxes is active (blue border) then the U2 is automatically set to be the 1 higher than U1.

To output ArtNet on the ethernet connector click **Activate** and then save the show to the Mantra Mini. To stop outputting ArtNet click **Deactivate** and then save the show to the Mantra Mini.

Note: When using Art-Net, Mantra Mini must have a valid IP address and NetMask entered in the “Network Settings” in order for Art-Net to work correctly. It is essential that the IP address is set to be compatible with the address on the device sending the Art-Net packets. Set the IP address according to the ArtNet recommendations using a 2.0.0.0. address range.

See section 18.5.3 for ArtNet Input settings.

18.5.2 sACN Output

From the home screen click **Tools, Setup, Universes**, click the **sACN** tab.

sACN (Streaming ACN) is an informal name for the E1.31 streaming protocol to transport multiple DMX universes over an Ethernet cable/network. Mantra Mini can transmit sACN from the Ethernet connector.



sACN Output

sACN uses a priority system. The priority level is set by the sACN transmitting device. If a device receives more than one sACN signal on the selected universe it will only respond to the signal with the highest priority setting. The default setting is 100.

In the “U1” box, enter the number of the sACN universe that is to be mapped to the fixtures that have been patched to U1 in the Patch screen.

In the “U2” box, enter the number of the sACN universe that is to be mapped to the fixtures that have been patched to U2 in the Patch screen.

Click **Apply**.

If the “Link” symbol between the U1 and U2 boxes is active (blue border) then the U2 is automatically set to be the 1 higher than U1.

To output sACN on the ethernet connector click **Activate** and then save the show to the Mantra Mini. To stop outputting sACN click **Deactivate** and then save the show to the Mantra Mini.

18.5.3 Override

Mantra Mini can accept a DMX-512, Art-Net or sACN input signal from any other lighting console and can automatically override its own playback and retransmit the incoming signal (on the Mantra Mini’s output universes) when it detects the incoming signal.

Example 1.

Mantra Mini is outputting on sACN Universe 1. Input is set receive data in sACN universe 3. When Mantra Mini sees data on sACN universe 3, it re-transmits that data on sACN Universe 1 (instead of its own data).

Example 2.

Mantra Mini is outputting on DMX 1. Input is set receive data in sACN universe 3. When Mantra Mini sees data on sACN universe 3, it re-transmits that data on DMX 1.

When the lighting console is turned off at the end of the show, the Mantra Mini detects that there is no input signal and the lighting control is automatically returned to the Mantra Mini’s normal playback after a short delay. The delay time is dependent upon the protocol in use. The lighting console that is to take control needs to have the same fixtures patched as in the Mantra Mini patch, except they will be patched to the DMX or sACN or ArtNet output that feeds the Mantra Mini input.

For example, a theatre has the house lights and some stage lights connected to the Mantra Mini. During simple shows or meetings etcetera, these lights are controlled by commands sent to the Mantra Mini. During stage shows, the lighting console in the control booth is used to control the lighting. The lighting console is programmed with a patch that contains the Mantra Mini’s lights and an output of the console is fed to an input of the Mantra Mini. When the Mantra Mini detects the signal from the lighting console, it automatically hands over control of its lights to the lighting console.

To configure an input to “override” the output, from the home screen click **Tools, Setup, Universes**.

Only one input signal (DMX or sACN or ArtNet) can be selected at a time. Selecting a different input signal automatically disconnects the any previous selection.

- To configure the ArtNet Input, click the **ArtNet** tab.

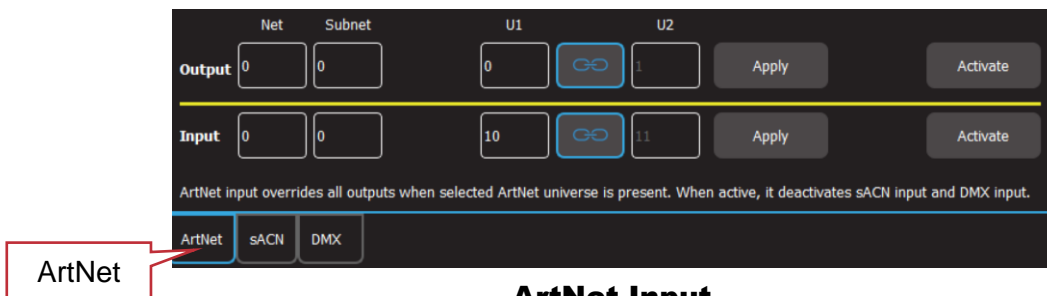

ArtNet Input.

On the “Input” row, set the Net, Subnet and “U1” values of the incoming ArtNet universe that is to be mapped to the fixtures patched to Mantra Mini’s U1 output and set the “U2”

value to the incoming ArtNet universe that is to be mapped to the fixtures patched to Mantra Mini's U2 output.

Click **Apply**.

If the "Link" symbol between the U1 and U2 boxes is active (blue border) then the U2 is automatically set to be the 1 higher than U1.

Click **Activate** and then save the show to the Mantra Mini.

Note: Both ArtNet and sACN override can accept two universes. If two universes are selected and only one universe appears it will override its output universe and the other output universe will remain controlled by the Mantra Mini.

- To configure the sACN input, click the **sACN** tab.

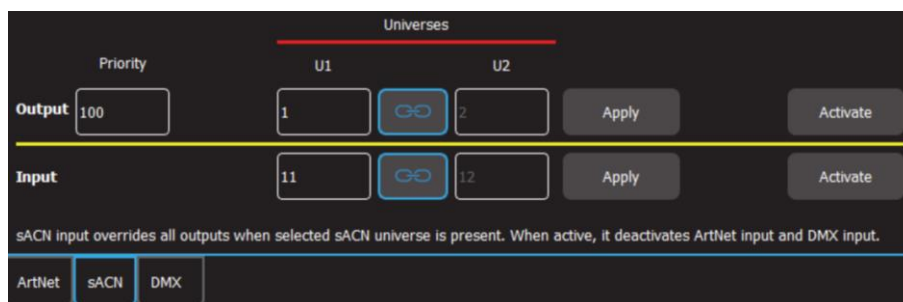

sACN Input.

On the "Input" row, set "U1" to the sACN universe that is to be mapped to the fixtures patched to Mantra Mini's U1 output and set "U2" to the sACN universe that is to be mapped to the fixtures patched to U2 output.

Click **Apply**.

If the "Link" symbol between the U1 and U2 boxes is active (blue border) then the U2 is automatically set to be the 1 higher than U1.

Click **Activate** and then save the show to the Mantra Mini.

- To configure the DMX input, click the **DMX** tab.

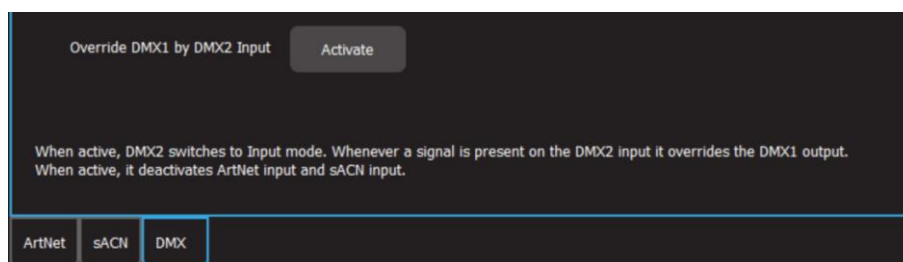

DMX Input

When active, the "Isolated DMX2" connector on the Mini switches to input mode and the incoming DMX signal is mapped to the fixtures patched to Mantra Mini's U1 output.

Click **Activate** and then save the show to the Mantra Mini.

Hint: "Override" mode can be completely disabled/enabled by a "Remote Trigger". See section 16.5.5.

18.6 View DMX

From the home screen click **Tools, Setup, Universes, View DMX**.

Select either **Universe 1** output or **Universe 2** output. The screen shows the DMX levels for all 512 DMX slots of the selected universe.

If a fixture has been patched to a slot number you can hover your mouse over a slot number to see the patch details for that slot.

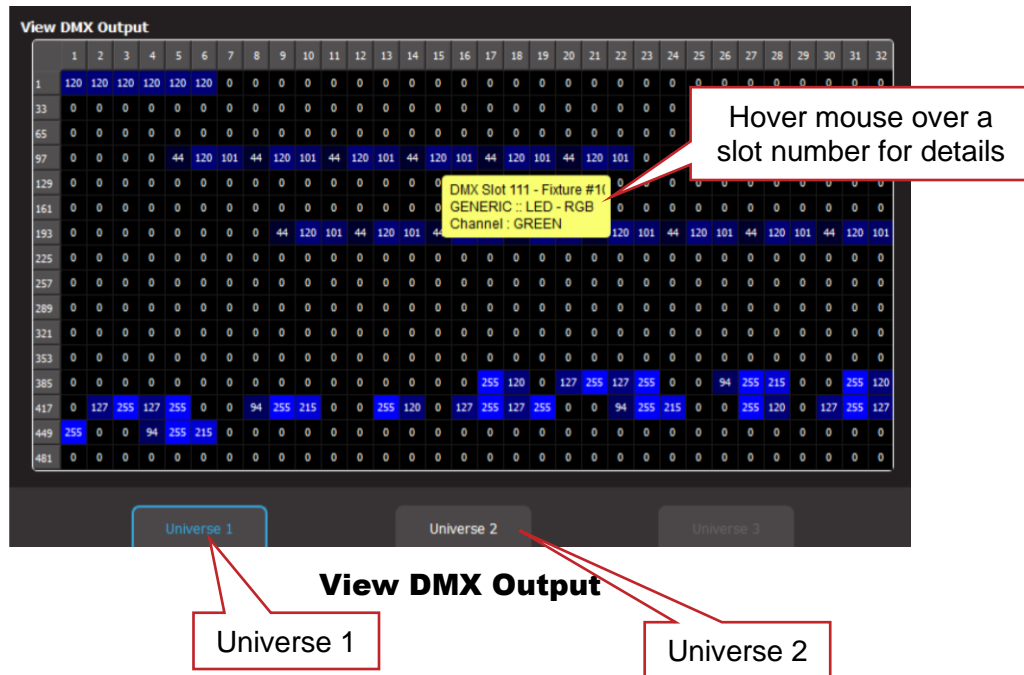

18.7 System Settings

From the home screen click **Tools, Setup, System Settings**.

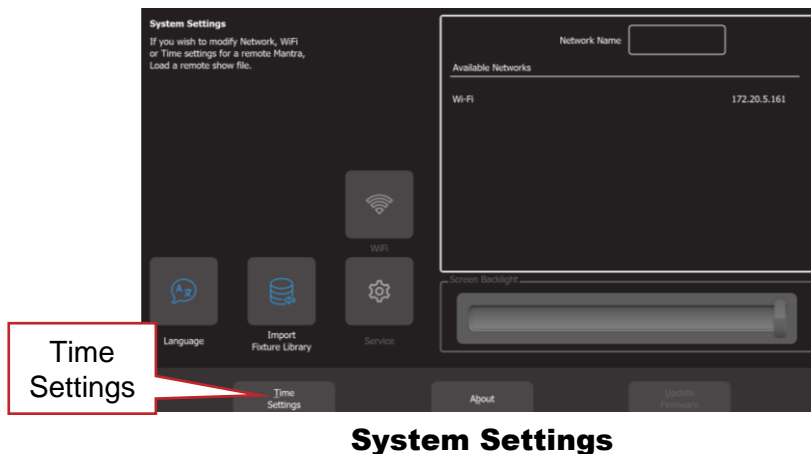

The “System Settings” screen has the following functions:

- Available Networks. See section 18.7.1
- Wi-Fi. See section 18.7.2
- Language. See section 18.10
- Import Fixture Library. See section 18.11
- Service. See section 0
- Time Settings. See section 18.13
- About. See section 18.14

System settings are saved internally in the Mantra Mini and are not included in show files.

18.7.1 Available Networks

When the Mantra Editor is not connected to the Mantra Mini, the “System Settings” page shows the “Available Networks” that can be selected to connect the computer or tablet running the Mantra Editor to the Mantra Mini. Click on a connection to use it to connect to the Mantra Mini.

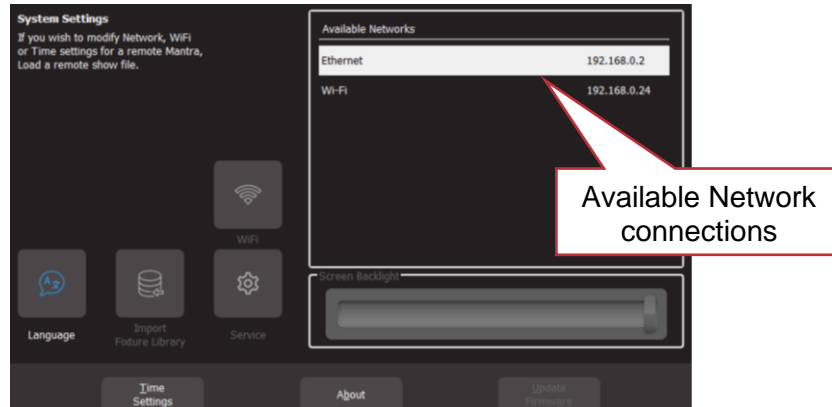

Mantra Editor Available Networks

18.7.1 Connecting via Ethernet.

To connect the Mantra Editor to the Mantra Mini via ethernet see section 5.5.

18.7.2 Connecting via Wi-Fi.

The Mantra Mini ships with its Wi-Fi set to operate as a “Wi-Fi Access Point” (WAP).

To connect the Mantra Editor to the Mantra Mini WAP, see section 5.4.

Once the Mini is connected to the Editor, the Wi-Fi can be changed to “Wi-Fi Client”. This allows it to connect to an existing Wi-Fi network. See section 18.9.

18.8 Mantra Mini Network Settings

When the Mantra Editor is connected to the Mantra Mini (by saving a show to the Mantra Mini or loading a show to the Mantra Mini), the “System Settings” page shows the network settings of the Mantra Mini.

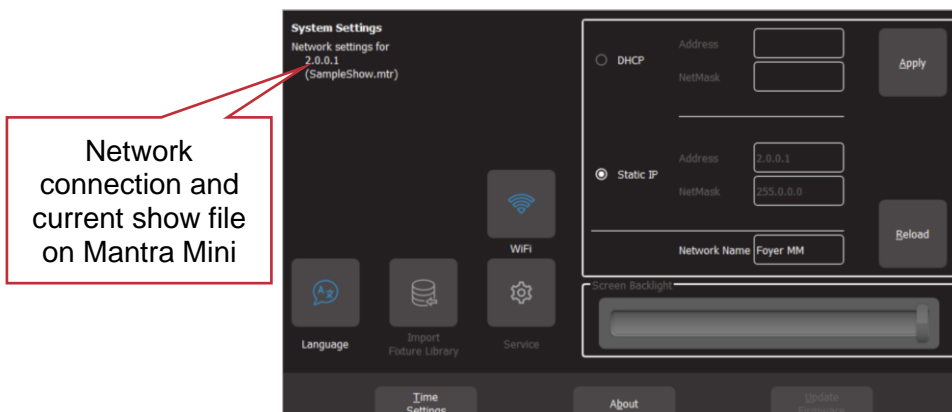

Mantra Mini Network Settings

18.8.1 Mantra Mini Network Name

You can enter a “Network Name” for the Mantra Mini. This is the name that will be displayed when you click “View Remote” when saving or loading a show.

18.8.2 Mantra Mini Network Address

You can have a network address automatically assigned by the network or you can manually enter an address.

- To have a network address automatically assigned select **Tools, Setup, System Settings**, then in the “Network” box click **DHCP**. Use this setting when connecting to a network router. Most consumer **routers** are set up to use **DHCP** and will automatically assign an IP address to the Mantra Mini.
- To manually enter a network, select **Tools, Setup, System Settings**, then in the “Network” box, click **Static IP** and enter the Address and Net Mask. Use this setting when streaming ArtNet or sACN over a dedicated lighting network.

18.9 Wi-Fi Client

Mantra Mini has inbuilt, short range Wi-Fi allowing you to easily connect your computer for system configuration and cue programming of the Mantra Mini. The Wi-Fi can operate in two modes.

Wi-Fi Access Point (WAP). The Mantra Mini ships from the factory in WAP mode. This allows you to easily connect a computer directly to the Mantra Mini WAP.

The default name for the Wi-Fi is “MantraMini ####”, where #### is a unique number.

The default password for the Wi-Fi is “mantra_mini”.

See section 5.4 for directions on how to connect the editor to the Mantra Mini WAP.

Wi-Fi Client. Mantra Mini can connect to an existing Wi-Fi network as a “Client”. This allows you to connect a computer to the same Wi-Fi network and hence connect to the Mantra Mini. The Mantra Mini must first be connected to the computer via ethernet. The computer is then used to change the Mantra Mini’s Wi-Fi from WAP to client mode and then to connect the Mantra Mini to the existing Wi-Fi network.

Steps for connecting the Mini as a Client to an existing Wi-Fi network.

1. Connect the Mantra Editor to the Mantra Mini using the ethernet connection. See section 18.7.1. Using ethernet allows you to alter the Wi-Fi settings whilst remaining connected.
2. Click **Tools, Setup, System Settings, Wi-Fi**
3. Click **Wi-Fi, Client** then **Refresh** to see the available networks
4. Click on the desired Wi-Fi network **name** then enter the **Password**. Optionally enter the static IP address and Netmask of the Wi-Fi network.
5. Click **Apply**.
6. Disconnect the computer from the Mantra Mini by loading a local or new show.
7. Open your computers Wi-Fi settings and connect to the same Wi-Fi network that was selected for the Mantra Mini in step 4. When using Microsoft Windows to connect to a Wi-Fi network, you must set your computers network profile to “Private”. To manually change the network profile to “Private”, click the available Network icon in the Notification area.

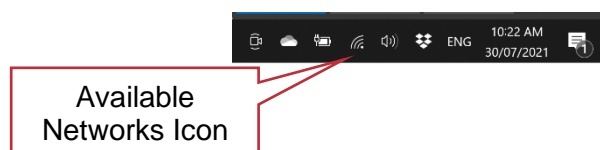

Select the WiFi network that you are connected to and then click **PropertiesB**. In the “Network profile” that opens select **Private**.

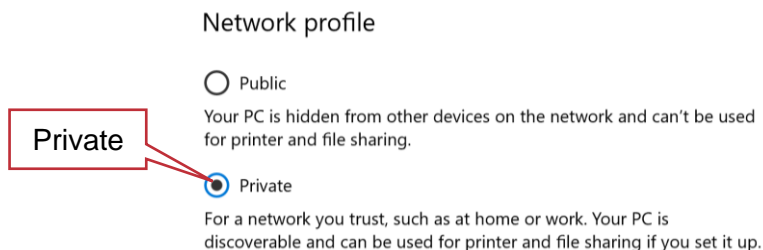

8. In the Mantra Editor, click **Tools, Setup, System Settings** and in the Available Networks pane, select the same Wi-Fi network.
9. To re-connect to the Mantra Mini click **Tools, Save Show As, View Remote**, click on the Mantra Mini **Icon**, type in a show name then click **Save**.

18.10 Language

Context sensitive help is available on for many functions. Click **Help** to open the help screen. Help pages will be are available in several languages. To select a language, from the “Home“ screen click **Tools, Setup, System Settings, Language** then click the language of your choice. This is a future feature.

18.11 Import Fixture Library

In the Patch menu you tell Mantra Mini the manufacturer/model and DMX address of each of fixture it is controlling. Mantra Mini then loads a “template” for that manufacturer/model of fixture from its fixture library. The template tells Mantra Mini how to control that fixture.

The Mantra Mini uses the Carallon fixture library. This provides over 5,500 fixtures, most with multiple operating modes, all included as standard with the Mantra Mini. Updates for this library are released from time to time by LSC and can be downloaded and imported into Mantra Mini.

The fixture library contains a version number that is displayed in the “About” screen.

To update the fixture library, perform the following steps,

1. Download the latest Mantra Mini fixture library from Iscontrol.com
2. Create a folder named “LSC” on a blank USB memory stick
3. Copy the library file into the “LSC” folder on the USB stick
4. Insert the USB Stick into the front panel of the Mantra Mini device
5. The front panel LEDs will all flash
6. Press the ‘user’ button within 5 seconds
7. The process takes approximately 90 seconds.
8. Once complete, the unit will restart
9. If the button is not pressed within 5 seconds, simply remove the USB stick, wait 10 seconds and re-insert.

Note: Mantra Mini software updates also include the latest version of the fixture library.

18.12 Service

No user functions are in this screen. It is for factory use and is PIN protected.

18.13 Time Settings

Mantra Mini needs to know the current time and daylight savings information at its location so that events that are saved in its “Schedule” can be executed at the correct time. The Mantra Mini has an internal clock that can be set by either of two methods.

1. Manually from the Mantra Editor.

- Automatically from a NTP (Network Time Protocol) server (see below).

If the Mantra Mini clock loses its time setting, the power LED repeatedly double flashes.

18.13.1 Manual Time Setting

To set the time of the Mantra Mini, connect the Mantra Editor to the Mantra Mini (by loading a show from or saving a show to the Mantra Mini) then from the “Home” screen, click **Tools, Setup, System Settings, Time Settings**. Enter the “Time Zone” and optionally the “Location” and “Daylight Savings” as described below then click **Apply**.

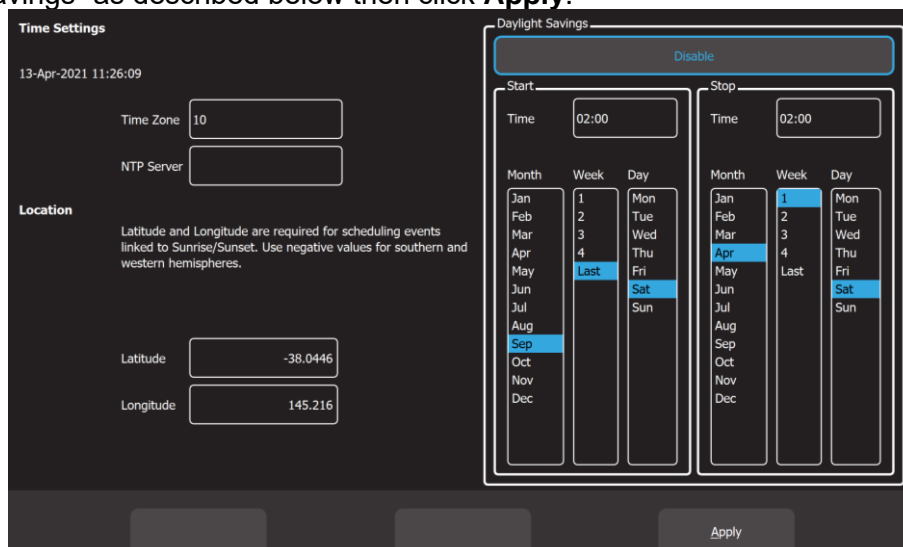

Time Settings

18.13.1 Time Zone

Mantra Mini needs to know the time zone in which it is located. The world is divided longitudinally into time zones, with each an hour or half hour difference. The starting point at which Coordinated Universal Time (UTC) starts is the Prime Meridian. Enter the UTC time zone for the location of the Mantra Mini. For example, Melbourne Australia’s time zone is 10. Click **Apply**.

18.13.2 Daylight Savings

Daylight Savings is the practice of advancing clocks one hour during the warmer months of the year. Not all locations observe daylight savings.

If the Mantra Mini is located in a region that does observe daylight savings, in the “Daylight Savings” pane click **Enable** then in the “Start” pane, select the “Month”, “Week” “Day” and enter the time that daylight savings begin for your region. In the “Stop” pane, select the “Month”, “Week” “Day” and enter the time that daylight savings ends for your region. Click **Apply**.

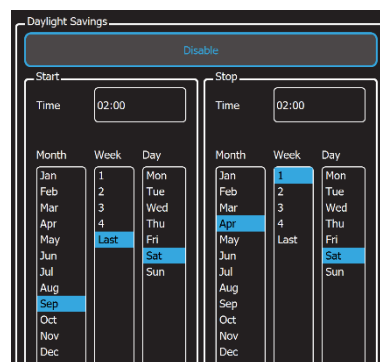

18.13.1 Location

If events have been scheduled to occur at Sunrise/Sunset, Mantra Mini needs to know its location in the world so that it can calculate the sunrise time and sunset time on any date. Enter the Latitude and Longitude of the Mantra Mini’s location. Use negative values for southern and western hemispheres.

Hint: You can use Google maps to find your location. For example, if the Mantra Mini was located at LSC Control Systems in Melbourne Australia, open Google maps and search for LSC Control Systems.

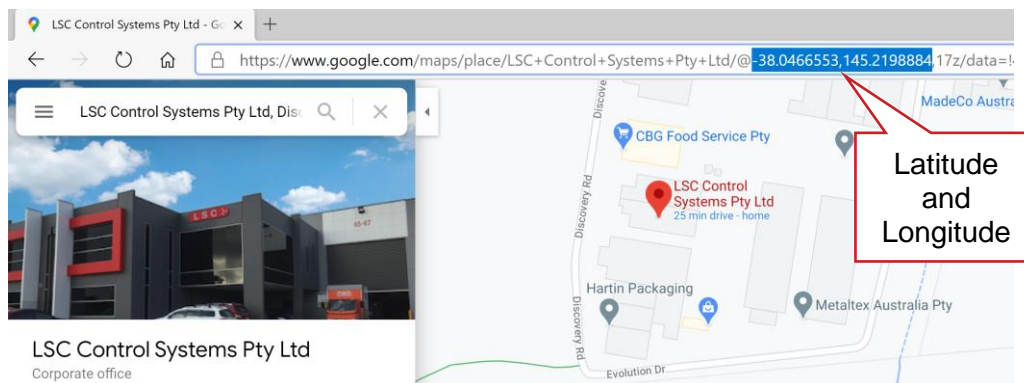

The Latitude and Longitude of the location can be found at the top of the page as highlighted in blue above. Type or copy and paste these co-ordinates into the Mantra Editor. Click **Apply**.

For example, the entries for LSC’s location would be:

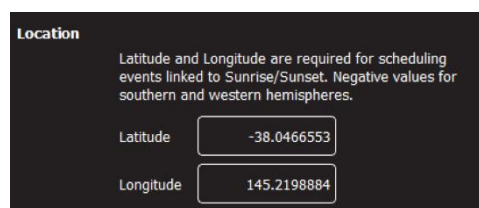

18.13.1 NTP Server

NTP (Network Time Protocol) is a networking protocol for clock synchronization over networks. You can synchronise the clock in the Mantra Mini to an NTP server or you can create your own NTP time server and run it on a private network. In either case, Mantra Mini must be connected to the network via either Wi-Fi or Ethernet.

To automatically set the date and time, enter the IP address of the NTP server into “NTP Server” box and set the “Time Zone” (see above) then click **Apply**.

18.14 About

To display the software version in your Mantra Mini, from the “Home” screen click **Tools, Setup, System Settings, About**. The fixture library contains a version number that is also displayed in the “About” screen.

LSC has a policy of continuous improvement of its products. The Mantra Mini’s software is subject to this policy as new features are added and existing features improved.

18.14.1 Download Log File

If you have contacted LSC technical support regarding the operation of your Mantra Mini, you might be asked to download the log file and send it to LSC. The **Download Log File** button appears on the “About” screen when the Mantra Editor is connected to the Mantra Mini. The Mantra Editor is connected whenever you load a show from or save a show to the Mantra Mini.

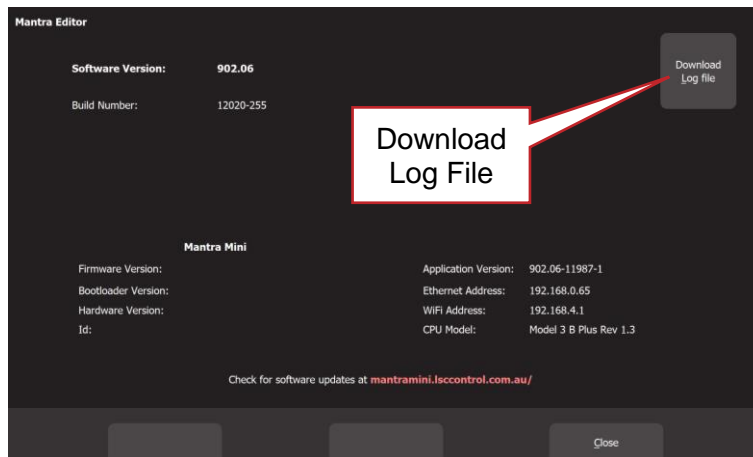

18.15 Update Firmware (Software)

The latest software for the Mantra Mini can be downloaded from:

<http://mantramini.lsccontrol.com.au>

There are two methods available to update the software on the Mantra Mini.

Method 1 using a USB memory stick.

To install a software update from a USB memory stick, perform the following steps:

1. Download the latest Mantra Mini software from “mantramini.lsccontrol.com.au”.
2. Create a folder named “LSC” on a USB memory stick.
3. Copy the downloaded software file named “mantra_mini_v???.img” (where ‘???’ is the software version number) into the “LSC” folder on the USB stick.
4. Insert the USB Stick into the Mantra Mini.
5. If a valid upgrade file is found by the Mantra Mini, all front panel LEDs will triple flash. This may take a few seconds to occur.
6. Within 5 seconds of the LEDs starting to triple flash, press the **USER** button to start the upgrade. All the LEDs now slow flash to show that the file is uploading. If you don't press the USER button, the update does not happen. If you do want to update, but are too slow, remove the USB stick, wait a few seconds and then start again at (4).
7. After a short time, the front panel LEDs start to chase from right to left. This indicates that the GUI (Graphical User Interface) part of the software is being updated. Some software updates will also include new interface software. If this is the case, the LED chase will change direction and chase from left to right as the interface software is being updated. The update takes a while, please be patient.
8. When the updates are completed the front panel LEDs triple flash several times and then normal operation will resume.
9. Remove the USB stick to finish.

Method 2 using HOUSTON X.

To install a software update using LSC's HOUSTON X software perform the following steps:

1. Connect the HOUSTON X computer to the same network as the Mantra Mini
2. Run the HOUSTON X application.
3. HOUSTON X will find the Mantra Mini.
4. Select the MantraMini tab.
5. In the APP VER column, double click on the **version number**. The Mantra Mini software will be upgraded.
6. The upgrade includes both the APP (Application) and I/F (Interface) software.

See section 22 for more information on HOUSTON X

19 Fixture Editor

19.1 Overview

The Mantra Mini uses the Carallon fixture library. This provides over 5,500 fixtures, most with multiple operating modes. Mantra Mini software updates also include the latest version of the fixture library.

In the Patch screen you tell Mantra Mini the manufacturer/model and DMX address of each of fixture it is controlling. Mantra Mini then loads a “template” for that manufacturer/model of fixture from its fixture library. The template tells Mantra Mini how to control that fixture.

If you have a new fixture and it is not listed in the Mantra Mini fixture library you can create a custom template for it, even if you don’t know the functions of its DMX channels. The Mantra Mini Fixture Editor allows you to use the “Intensity” wheel to directly control the DMX channels of the fixture and hence identify the function of each channel. You then select an attribute name for each identified channel, then name and save the new template. You can also use the Fixture editor to edit an existing fixture template.

19.2 Creating a Custom Fixture Template

In normal operation (not in the “Fixture Editor”), the intensity wheel controls the intensity of the selected fixtures. When you open the “Fixture Editor” the intensity wheel changes and controls the DMX level of the DMX address that you specify in the editor.

For example, you connect your new fixture to the DMX output of Mantra Mini and set the fixtures DMX address to 1. If you enter a DMX address of 1 in the fixture editor, the Intensity wheel controls the first channel of the fixture. Move the wheel to how the fixture responds and hence identify the function of channel 1 of the new fixture. Set the DMX address in the editor to 2 and move the wheel and function of that channel 2 etcetera.

To open the Fixture Editor, from the “Home” screen click: **Tools, Setup, Patch, Fixture Editor:**

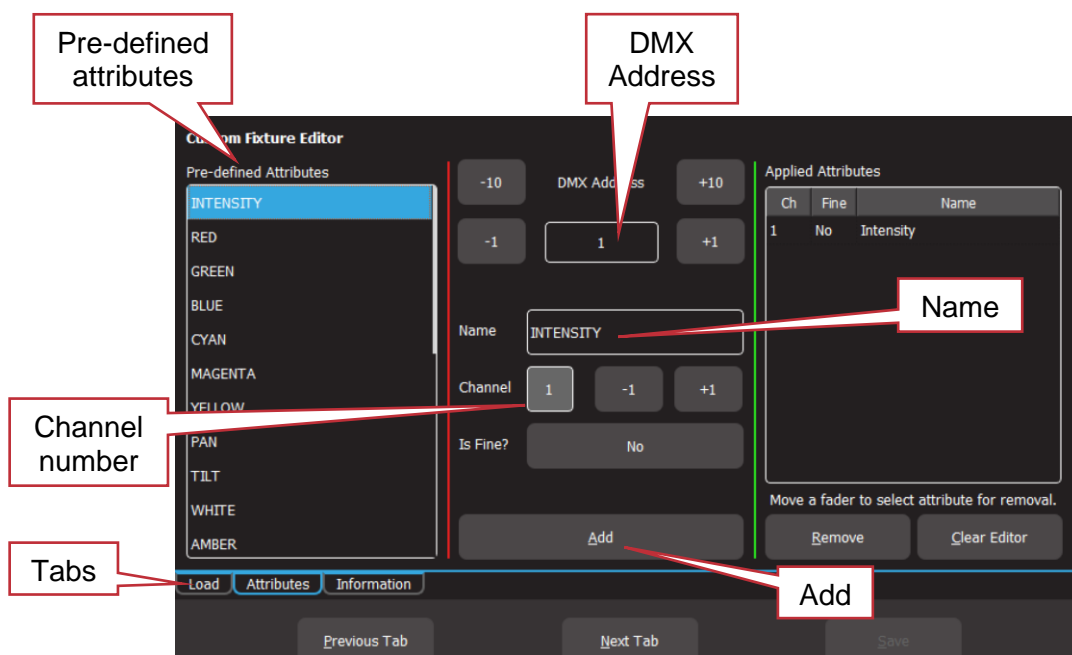

Custom Fixture Editor (Attributes Tab)

There are 3 screens that are selected by the “Tabs”:

1. Load.
2. Attributes
3. Information

The editor opens on the "Attributes" Tab. Connect the new fixture to the Mantra Mini DMX output. Ensure that the Fixture editor and the new fixture are set to the same DMX address. Move the Intensity wheel. Observe the operation of the fixture. Which attribute of the fixture is the intensity wheel controlling? Select the appropriate Attribute name for this channel from the list in the “Pre-defined Attributes” box. Scroll the list for more names. If no suitable name exists either choose “Unknown” or click the “Name” box and enter a descriptive name. To create the attribute for this channel click **Add**. The Channel Number is automatically incremented ready for the next channel.

Increment the DMX address in the editor. Observe the operation of the fixture when you move the intensity wheel and repeat the above procedure to add the attribute.

If an attribute is used for fine control of a function, click the **Is Fine?** field. It will toggle to “Yes”. Typically, this will be where 2 channels are used for movement. One channel will be the course control and the other will be for fine.

If you make a mistake on a channel, select that channel then click **Remove**.

When all attributes have been identified and added click **Next Tab** (Information).

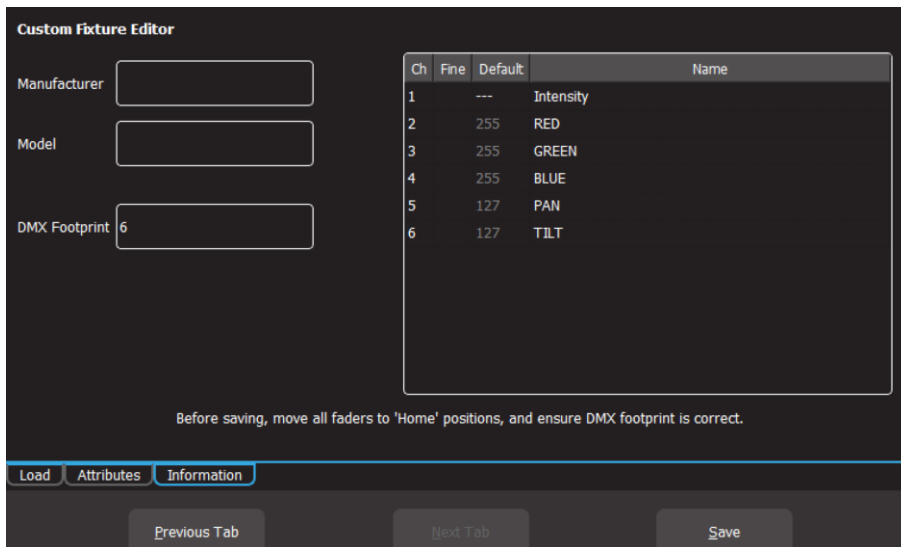

Custom Fixture Editor

Manufacturer

Model

DMX Footprint

Ch	Fine	Default	Name
1	---		Intensity
2	255	RED	
3	255	GREEN	
4	255	BLUE	
5	127	PAN	
6	127	TILT	

Before saving, move all faders to 'Home' positions, and ensure DMX footprint is correct.

Load Attributes **Information**

Previous Tab Next Tab Save

Custom Fixture Editor (Information Tab)

Enter a Manufacturer and Model name. If you don't know the manufacturers name enter “Unknown” or you can use any name that helps you organise your fixtures. For example, “Gregs Fixtures”.

Check the specifications of the fixture and determine the quantity of DMX channels that it actually uses. This is known as the fixtures “DMX Footprint”. Every time you “Add” an attribute in the fixture editor it automatically increments the count in the “DMX Footprint” field. Some fixtures provide DMX channels for functions that you do not require and hence you might not have added Attributes for these channels. If this is the case you must manually enter the correct number of DMX channels actually used by the fixture in the “DMX Footprint” field. This ensures that Mantra Mini will not overlap DMX addresses when patching multiple fixtures.

19.2.1 Home Positions

Home positions for Gobos, Zoom/Focus, colour and shutter/strobe attributes are saved in the template.

- Select each DMX address and use the intensity wheel to set the values required for the fixtures "Home" position. The recommended "Home" attribute settings are:
- All Gobos set to open.
- Zoom/Focus at 50%.
- No colour.
- Shutter/Strobe fully open.

Note: The Intensity, RGB/CMY colours and Pan/Tilt attributes are ignored when setting the Home position. These attributes are always set to the same Home values:

- Intensity = zero.
- RGB/CMY Colour = white. RGB are at 100% and CMY are at 0%.
- Position = centre.

So, despite what the fixture information shows for both factory and user created templates, the "default" values for intensity, RGB/CMY and Position (Pan/Tilt) will not be what is shown in the fixture information window nor what is set in the fixture editor.

All of these Home values are applied to the fixture when the fixture is "cleared".

Click **Save** to create the new template.

19.3 Edit a Fixture Template

If you want to edit an existing fixture, from the "Home" screen click: **Tools, Setup, Patch, Fixture Editor**, then select the "Load" tab.

Select the fixture template that you want to edit then click **Load**.

Edit the fixture settings in the "Attributes" and "Information" tabs as described in section 19.2 and then save the edited template.

20 Companion/StreamDeck OSC Control

20.1 Overview

The Elgato StreamDeck © is an affordable and customizable USB button panel. Bitfocus Companion is free third-party software that enables the StreamDeck to send OSC messages that can be used to control the Mantra Mini via “Remote Triggers”.

The OSC messages can play any cue at any level with any fade time or play the “next cue” in a specified memory (cue-list) or enable/disable “override” mode or “evacuation” mode.

See section 16.4 for more information on OSC remote triggers.

The Companion software is run on a computer that is connected to the same network as the Mantra Mini. The StreamDeck plugs into a USB port of the same computer.

The buttons on the StreamDeck are fully programable and each button can be configured to send an OSC message to the Mantra Mini.

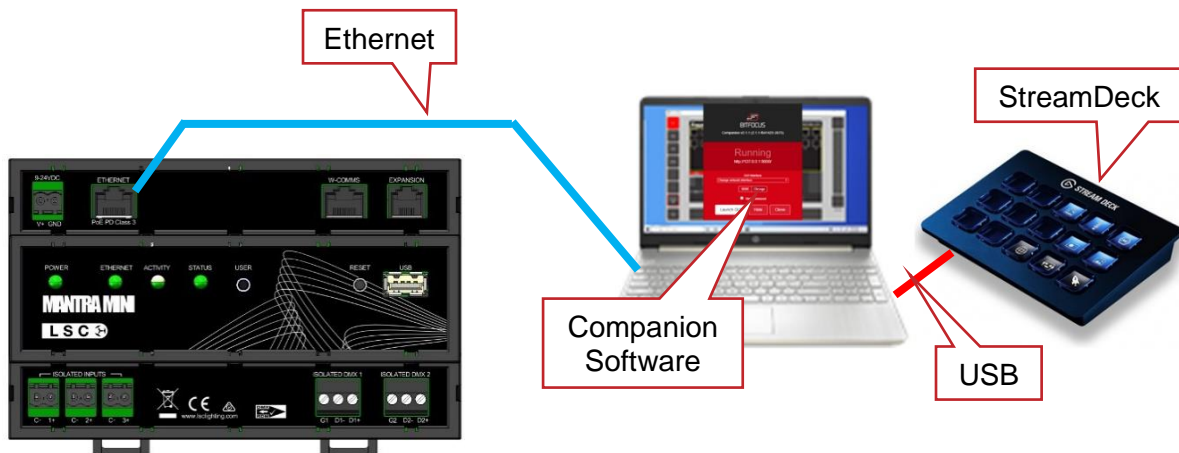

Typical StreamDeck Setup

20.2 Programming Companion

This description covers the basics in configuring a StreamDeck button to send an OSC message to the Mantra Mini. You can find information online on how to setup a StreamDeck, how to customise StreamDeck buttons and also about advanced StreamDeck programming.

These instructions must be read in conjunction with section 16.4 “OSC Remote Triggers”.

Companion software can be downloaded from: <https://bitfocus.io/user/downloads>

Run Companion.

Check that the “GUI Interface” is set to “localhost / 127.0.0.1”.



Click **Launch GUI**. The GUI opens in your WEB browser.

In the “Instances” tab select **Add by category** then click **Generic, Generic OSC**. Click the “Config” tab. In the “Target Port” pane, enter a port number”. Choose any random number in the range 1 to 65535. In the “Target IP” pane, enter the IP address of the Mantra Mini to be controlled. The IP address can be found in the Mantra Mini’s “System Settings”, “Available Networks” screen. If you are running the Mantra Editor alone (without a Mantra Mini connected to the network) set the “Target IP” to the loopback IP address, 127.0.0.1.

Open the “Mantra Editor” program. Select **Tools, Setup, Remote Triggers, Add**. Select **OSC, Play Memory**. Click and drag in the message pane to select the message then copy it so that it can be pasted into Companion later on. Enter the same port number that was set in the Companion Config tab. Name the trigger then **Save**.

Back in the Companion GUI, click the “Buttons” tab, click the button that you want to configure. In the “Edit Button” tab on the right, click “Set Button Type” then choose “Regular Button”. In the “Text” pane, type the label for the button.

Click “Add key down/on action” then choose “Send message without arguments”.

In the “OSC Path” pane, replace the text by pasting the text previously copied from the Mantra Editor. In the pasted text, replace each of the “\$variables” with the actual variables that you require for the OSC message.

For example:

The pasted OSC message is:

```
/PlayMemory/Page=$p/Memory=$m/Cue=$c/Level=$l/Fade=$t
```

To play Page 1, Memory 2, Cue 3 at a level of 100% with a fade time of 4 seconds, replace the variables with the required values.....

```
/PlayMemory/Page=1/Memory=2/Cue=3/Level=100/Fade=4000
```

Note: The fade time is entered in milliseconds. 1 second = 1000 milliseconds.

To program another StreamDeck button to send a different message, click on the button, set the type, text and paste the same message but replace the variables with different values. For example, to fade down the cue, send an OSC message with a level of 0%.

Hint: When programming keys for “Next Cue”, Override or Evac Mode, the message generated by the Mantra Mini does not have any variables so simply copy and paste the message directly into the Companion “OSC Path” pane without editing it.

Hint: It is very easy to make a flash key on the StreamDeck. Program the key down action to play the cue at 100% and the key up action to play the cue at 0%.

21 Touch OSC Control

21.1 Overview

“Touch OSC” is a touch screen app for IOS and Android phones and tablets. It can send OSC messages over Wi-Fi to compatible devices such as the Mantra Mini. The OSC messages can be used to control the Mantra Mini via “Remote Triggers” and can play any cue at any level with any fade time or play the “next cue” in a specified memory (cue-list) or enable/disable “override” mode. See section 16.4 for more information on OSC remote triggers.

Touch OSC consists of two parts.

1. The first part is the “Touch OSC Editor”. It is a program on a computer that is used to create the buttons and their commands that can be used in the “Touch OSC App” (see below). The buttons that you create on are fully programable and each button can be configured to send a different OSC message to the Mantra Mini. Touch OSC Editor can be downloaded from hexler.net/products/TouchOSC. Comprehensive help files are available on line for Touch OSC.
2. The second part is the “Touch OSC App”. When the buttons, their OSC commands and their labels have been created in “Touch OSC Editor”, the “current layout” is “Synced” via Wi-Fi to the “Touch OSC App” on the phone or tablet. The computer running the “Touch OSC Editor” and the phone or tablet running the “Touch OSC App” must be connected to the same Wi-Fi network for the “Sync” to occur. The computer running “Touch OSC Editor” is no longer required after syncing unless different buttons need to be programmed. The Touch OSC App is available for free download from your App store.

The phone or tablet running the “Touch OSC App” must be connected to the Mantra Mini Wi-Fi or to a Wi-Fi that is connected to the same network as the Mantra Mini so that the “Touch OSC App” can send the OSC commands over Wi-Fi to the Mantra Mini.

21.2 Programming Touch OSC

The following is a brief description of how to program one button to play a cue on the Mantra Mini. Multiple buttons can be created and each can perform a different function.

Open the “Touch OSC” app on the phone or tablet. Select “Connections”, “OSC” then enter the IP address of the Mantra Mini Wi-Fi.

*Hint: The IP address of the Mantra Mini Wi-Fi can be found when the Mantra Editor is connected to the Mantra Mini. To connect either load a show from the Mantra Mini or save a show to the Mantra Mini then select **Tools, Setup, System Settings, WiFi**. The Wi-Fi IP address is shown in the “DHCP Base” pane.*

Alternatively, open LSC’s “HOUSTON X” software (see section 22) and click on the Mantra Mini tab.

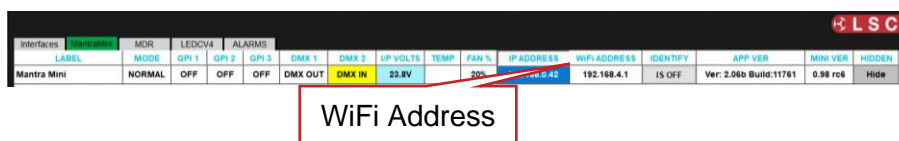

INTERFACES	MANTRA MINI	MOR	LEDCV4	ALARMS	DMX 1	DMX 2	IP VOLTS	TEMP	FAN %	IP ADDRESS	WiFi ADDRESS	IDENTIFY	APP VER	MINI VER	HIDDEN
Mantra Mini	NORMAL	OFF	OFF	OFF	DMX OUT	DMX IN	23.8V		20%	192.168.4.1	192.168.4.1	IS OFF	Ver: 2.06b Build:11761	0.98 r08	Hide

HOUSTON X

Take note of the “Port (outgoing) number in Touch OSC. This is usually 8000 but you can use any number as long as the same port number is entered in the Mantra Mini.

Open the “Mantra Editor” program. Select **Tools, Setup, Remote Triggers, Add**. Select **OSC, Play Memory**. Click and drag in the message pane to select the message then copy it so that it can be pasted into Touch OSC Editor later on. Enter the same port number that was set in Touch OSC App. Name the trigger then click **Save**.

Open the Touch OSC Editor program. Right click on the virtual device screen and select “Push Button”. The button appears and can be resized, positioned and coloured.

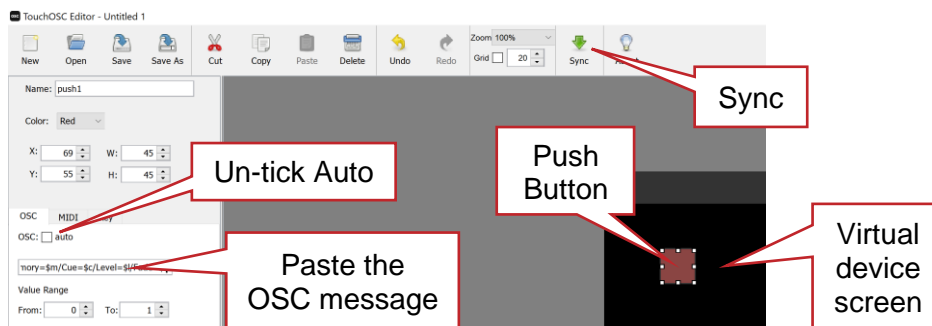

Touch OSC Editor

In the OSC tab, un-tick the “Auto” box then click in the message box and paste the OSC message that was copied from the Mantra Editor. In the pasted text, replace each of the “\$variables” with the actual variables that you require for the OSC message.

For example:

The pasted OSC message is:

```
/PlayMemory/Page=$p/Memory=$m/Cue=$c/Level=$l/Fade=$t
```

To play Page 1, Memory 2, Cue 3 at a level of 100% with a fade time of 0 seconds, replace the variables with the required values.....

```
/PlayMemory/Page=1/Memory=2/Cue=3/Level=100/Fade=0
```

A label for the button can be inserted by right clicking on the virtual device screen and selecting “Label H” then entering “Text” for the label.

Save the layout and take note of the file name. This is the name that you will later select in the Touch OSC App.

Connect the computer running the Touch OSC Editor and the phone (or tablet) running the Touch OSC App to the same Wi-Fi as the Mantra Mini.

In the Touch OSC App select “Layout”, “Add”.

In the Touch OSC Editor click “Sync”.

The layout will be transferred to the App via Wi-Fi.

Hint: If the transfer does not automatically work, in “Add Layout” select “Edit” then “+”. Enter the IP address of the Wi-Fi.

In the Touch OSC app select “Layout”, then select the layout name that you created in the Touch OSC Editor. Select “Done”. The layout appears on the screen of the phone or tablet. Touch the button that you created to send the OSC remote trigger to the Mantra Mini.

22 HOUSTON X

HOUSTON X is LSC’s monitoring and remote configuration tool that works with LSC products such as APS, GEN VI, MDR-DIN, LED-CV4, UNITOUR, UNITY and Mantra Mini. HOUSTON X can be downloaded from the LSC website, www.lsccontrol.com.au

HOUSTON X is the central overseer of your venue’s equipment. The software runs on Windows and Mac computers. It gives you the absolute authority to interrogate, monitor and instantly change parameters of connected products. Using HOUSTON X, you can quickly locate and isolate faults, monitor temperatures, phase loadings, change a channel from dimmer to power-switching mode (TruPower), save or recall show configurations, all from one central location or remotely via the internet.

When connected to a Mantra Mini, HOUSTON X can monitor the following,

Parameter	Information
Mode	Normal or Output Override
GPI 1 - 3 (Isolated Inputs)	Off or On
DMX 2	Output or Input
I/P Volts	Voltage reading
Temp	Internal Temperature
Fan %	Fan Speed
IP Address	IP Address. Double click to change
Wi-Fi Address	Wi-Fi Address
Identify	RDM Identify, On or Off. Click to make the device identify itself
App Ver	Mantra Mini software version number
MINI Ver	Mantra Mini interface version number
Hidden	The device can be shown or hidden in HOUSTON X

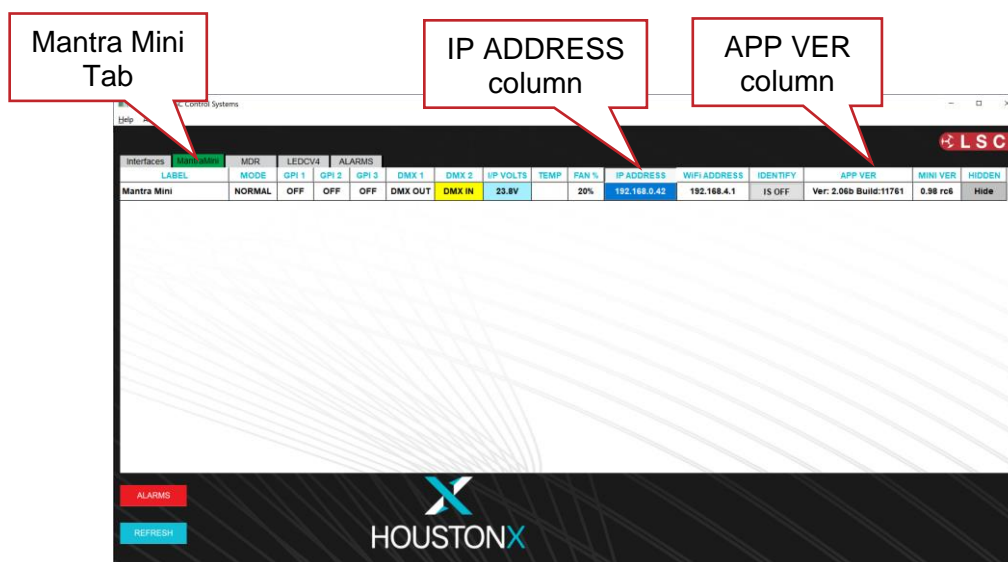

To update the Mantra Mini software, double click on the version number in the APP VER column.

To change the IP address of the Mantra Mini, double click the IP address in the “IP ADDRESS” column. A dialog box opens allowing you to change the IP settings of the selected Mantra Mini.

To identify a Mantra Mini, click **Identify**. The four LEDs on the front panel the Mantra Mini will flash in pairs, the left pair then the right pair.

23 FAQ

Q. Some of my fixtures still have colours selected.

A. Clear the fixtures. From the “Home” screen click **Apps, Clear All**.

A. Clear all playbacks. Click **All Cues Off**.

Q. Some of my moving fixtures are still moving, even when their intensity is faded down.

A. Clear the animations on those fixtures. Select the fixtures to be cleared from the **Select** screen. Click **Apps, Clear**. In the “Animations/Delete” pane click **Position**.

You can also clear all animations and all attributes of all fixtures. From click **Apps, Clear All**.

Q. I can't see some of my channels animating on the output.

A. Fade down all playbacks. One of them might contain some of the channels you are animating and the playback has precedence.

Q. I can't get any intensity output from some of the fixtures.

A. There might be an intensity animation still running and it has priority. Delete the animation. From the “Home” screen click **Apps, Clear All**.

Q. My animation is running strangely.

A. Animations respect your fixture selection order. Make sure you have selected your fixtures in the desired order. You can see the selection order in the animation App.

Q. I created an animation set to “centre in” but only half the fixtures are animating.

A. Centre in and centre out animations work best with an odd number of fixtures so that the pattern is symmetrical around the centre fixture. If you have an even number of fixtures there is no centre fixture because the centre is the gap between fixtures. You must therefore program a symmetrical static look with at least one different setting on both sides of centre.

Q. I tried to record a cue but the screen said “There is nothing to record”.

A. Recording a cue only includes fixtures that have intensity greater than zero. Fade up the fixtures to be recorded. Also see section 12.6.

24 Feature History

The new features added to the Mantra Mini in each software release are listed below:

Release: v4.01

New Operating System. The underlying operating system has been updated to OSv6. This will allow LSC to upgrade to even more powerful CPU modules in the future, as well as providing faster boot times now. Most of the new features below are only possible because the updated OSv6.

Extended Colour Mixing. The colour picker now controls all colour mix colours, including Lime, Amber, Cyan, Royal Blue, etc. These are automatically calculated by the colour picker and converted into 4/5/6/7/8/9 colour mix parameters on the fly. The White parameter continues to be controlled by the vertical movement of the selection cursor.

Extended Colour Animations. The original Mantra software only understood RGB and CMY colours. This meant that colour animations only controlled those colours. With the addition of Extended colour mixing, colour animations have been expanded to also work across all colour mix parameters, including Line, Amber, Royal Blue etc.

Enhanced Colour Sliders Colour sliders now include a subtle colour band above the fader to graphically indicate the colour they control.

HSI (Hue Saturation Intensity) colour control The colour picker now supports fixtures that require HSI colour control. The RGB values are converted to HSI parameters on the fly.

Slider app changes. The slider apps for Colour and Attributes have been reworked with several new features and refinements.

- Colour sliders now include a subtle colour coded stripe above the slider to give a visual indication of the colour they are controlling.
- The level information at the right side is now shown as both a decimal value (0.255 or 0.65535) as well as a percentage value (0-100%).
- The order of colours in the colour sliders app was not always logical. Colour mix parameters (e.g. Red, Green, Blue, Amber, Lime, White) now appear first, followed by other colour parameters (e.g. Colour Mode, Macros, etc).
- Sliders in the Colour Sliders app did not have an option for Snap/Fade. This is not required for colour mix parameters but was a problem for parameters controlling Colour Wheels and Macros, as the default behaviour was fade and often users would prefer these to snap.

Viewing Log File. The Mantra Mini log file is very useful for the diagnostics of advanced functions including Remote Triggers and Scheduler events. There are now two methods to view the log files.

1. Download the log file from the Mantra Editor software. Go to [Tools], [Setup], [System Settings], [About] and click on the [Download Log file] button. A pop-up window will appear asking for a location to save the file.
2. Use a web browser to access the Mantra Mini log files. Enter the IP address of the Mantra Mini into any web browser to display the simple web page with the list of log files. Click on the name of the log file to view it. Use the browser's [Refresh] button to update the log file when required.

VNC (Virtual Network Computing) control. The Mantra Mini now supports basic remote control via VNC. Enter the Mantra Minis IP address into a VNC viewer (for example, Remote Ripple, TightVNC, etc) and the Mantra Mini screen will appear. Not all functions are supported (for example there is no Record or Page buttons), but it can be a very useful diagnostics tool for advanced debugging of show files. Use the mouse's right button as the Back/Home button when navigating. Note: The rig view is not active on the Mantra Mini, so this section of the screen will always be blank.

Release: v3.07 Date: 17 November 2022.

- Delete Custom Fixtures. A new button in the Setup window has been added to allow the user to delete the entire custom fixture library. All custom fixtures are also saved in any show to which they are patched, so after deleting the custom database, reloading shows will automatically add those fixtures to the library.

Release: v3.04 Date: 28 February 2022

- Fixture library version numbering. The fixture library now contains a version number that is displayed in the About screen. This is to aid users to check if their device has the latest library installed. The new library format is also provided with enhanced encryption to prevent tampering.
- Colour Picker now controls White in the vertical axis. The colour picker now controls the White colour parameter as well as RGB colours. Moving the pointer towards the white section at the bottom of the screen adds white proportionally in addition to the RGB colours.

- Software upgrade enhancements. If the power was disconnected during the software update, it was possible to corrupt the internal SD card. The upgrade process has been ruggedised to ensure that this is no longer possible.

Release: v3.01 thru v3.03

These versions were never released to the public.

Release: v3.00 Date: 1 August 2021

Initial Software Release.

25 Specifications

Control	<p>Up to 96 fixtures on 1024 DMX slots Up to 100 active simultaneous cues Massive memory – over 1000 shows can be stored internally Play default cues on power-up Status logging and reporting Remote app for Windows and MAC-based devices allowing loading, editing and storing of show information</p>
Inputs	<p>DMX512 (1990) and DMX512-A (E1-11) USB port for show data upload/backup and software upgrades Three isolated contact closure inputs via 2-pole plug-in screw terminals for fire, emergency or playing cues Live console override via Art-Net or sACN UDP via Ethernet for third-party remote control</p>
Outputs	<p>Dual DMX512 outputs via two 3-pole plug-in screw terminals Art-Net and sACN outputs via Ethernet connection Room linking via Ethernet, requires one Mantra Mini per room Expansion port for future proofing</p>
Power	<p>PoE (via RJ45 Ethernet connector) or 9-24V DC (20W max) supply via 2-pole plug-in screw terminals (external power supply not included)</p>
Mechanicals	<p>158mm (w) x 59mm (d) x 104mm (h) Weight: 350g TS-35 DINrail-mount, high-strength, flame-retardant ABS plastic chassis</p>
Peace of mind	<p>CE (European) and RCM (Australian) approved Two-year warranty Designed and manufactured in Australia by LSC, an Australian owned company with over 40 years' experience in developing world-first products</p>

26 Terminology

26.1 Overview

The following Terms are commonly used in this Mantra Mini User Manual. These Terms have been adopted by LSC as the best descriptions for functions and operations performed on the Mantra Mini and may not be terms universally adopted on similar equipment.

26.2 Fixture.

A multi-colour LED light, moving light, dimmer or any other DMX controlled device is known as a fixture. As you patch each Fixture you give it a unique Fixture Number.

26.3 DMX Address.

Every Fixture has a selectable DMX starting address and this is patched to that same DMX address number on the Mantra Mini. The Mantra Mini will then automatically patch all of the remaining DMX addresses for that Fixture according to the information in that particular Fixtures Template.

26.4 Template.

A Fixture Template is a file that tells the Mantra Mini the function of each DMX address for that fixture and it defines the Apps, controls and labels for that Fixture. Every different type of Fixture that you control requires a Template.

26.5 Fixture Library.

The Mantra Mini stores its fixture templates in a library. The templates are organised in the library by manufacturer and model. When you want to use a particular model of Fixture, you select its Template from the library.

26.6 Attribute.

Each brand and model of Fixture has a specified number and order of control channels. An attribute is one or two DMX control channels (two channels used for higher resolution) that uniquely controls one of the physical motions of the Fixture. The manufacturer's specification of a Fixture lists each attribute and its control channel number(s). Attributes are sometimes referred to as "Parameters".

26.7 LTP. (Latest Takes Precedence)

See section 13.4.

26.8 Look

A lighting "look" is the current output of the Mantra Mini. A "look" may be made up of a collection of fixtures or one or many cues or a combination of cues plus fixtures. It may even be a single fixture.

26.9 Cue

A Cue is a memorised look of fixtures (at their respective levels, colours and positions) plus any animations or shapes that were running when the cue was recorded. The cue can be given a name. Up to 100 cues can be played back at the same time.

26.10 DMX512A

DMX512A (commonly called DMX) is the industry standard for the transmission of digital control signals between lighting equipment. It utilises just a single pair of wires on which is transmitted the level information for the control of up to 512 DMX slots.

As the DMX512 signal contains the level information for all slots, each piece of equipment needs to be able to read the level(s) of the slots(s) that apply only to that piece of equipment. To enable this, each piece of DMX512 receiving equipment is fitted with an address switch or screen. This address is set to the slot number to which the equipment is to respond.

26.11 DMX Universes

If more than 512 DMX slots are required, then more DMX outputs are required. The slot numbers on each DMX output are always 1 to 512. To differentiate between each DMX output, they are called Universe1, Universe 2, etcetera. Mantra Mini provides 2 DMX universes.

26.12 ArtNet

ArtNet is a streaming protocol to transport multiple DMX universes over a single cat 5 Ethernet cable/network.

26.13 sACN

Streaming ACN (sACN) is an informal name for the E1.31 streaming protocol to transport multiple DMX universes over a single cat 5 Ethernet cable/network.

26.14 RDM

RDM stands for Remote Device Management. It is an “extension” to DMX. Since the inception of DMX, it has always been a ‘one way’ control system. Data only ever flows in one direction, from the lighting controller outwards to whatever it may be connected to. The controller has no idea what it is connected to, or even if what it’s connected to is working, switched on, or even there at all!

RDM changes all that allowing the equipment to answer back!

An RDM enabled moving light, for example, can tell you many useful things about its operation. The DMX address it is set to, the operating mode it is in, whether its pan or tilt is inverted and how many hours since the lamp was last changed.

But RDM can do more than that. It isn't limited to just reporting back, it can change things as well. As its name suggests, it can remotely manage your device.

RDM has been designed to work with existing DMX systems. It does this by interleaving its messages with the regular DMX signal over the same wires. There is no need to change any of your cables but because RDM messages now go in two directions, any in-line DMX processing you have needs to be changed for new RDM hardware. This will most commonly mean that DMX splitters and buffers will need to be upgraded to RDM capable devices.

27 Compliance Statements

The Mantra Mini from LSC Control Systems Pty Ltd meets all required CE (European), RCM (Australian) and UKCA (United Kingdom) standards.

CENELEC (European Committee for Electrotechnical Standardization).



Australian RCM (Regulatory Compliance Mark).



WEEE (*Waste Electrical and Electronic Equipment*).



The WEEE symbol indicates that the product should not be discarded as unsorted waste but must be sent to separate collection facilities for recovery and recycling.

For more information about how to recycle your LSC product, contact the dealer where you purchased the product or contact LSC via email at info@lsccontrol.com.au

You can also take any old electrical equipment to participating civic amenity sites (often known as 'household waste recycling centres') run by local councils. You can locate your closest participating recycling centre using the following links.

- AUSTRALIA <http://www.dropzone.org.au>.
- NEW ZEALAND <http://ewaste.org.nz/welcome/main>
- NORTH AMERICA <http://1800recycling.com>
- UK www.recycle-more.co.uk.

-END-